

VivaTech TeraHertz SAS Nice, France

VivaTech TeraHertz designs and manufactures custom solutions for TeraHertz (THz) components, modules and systems operating in the frequency range 50-1100 GHz.

VivaTech TeraHertz offers customized components, modules or systems for research and development applications in the TeraHertz and Sub-TeraHertz spectrum.

These include broadband frequency converters, extenders for microwave sources and Vector Network Analyzers (VNA). Applications include high data rate communications, automotive radar, plasma diagnostics amongst others.

*This **short form catalogue** offers examples of capability, based on decades of experience in mm-wave and THz development.*

VivaTech TeraHertz supports the calibration and repair of mm-wave and THz products from other manufacturers.

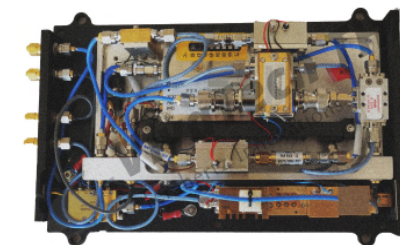

Contents Page 1 of 2

5G/6G Up Down Converters 75 - 350 GHz

| | |
|--|-----|
| 92-110 GHz Up-converters and Downconverters for 5G/6G Applications | 1 |
| 220-260 GHz Downconverters for 5G/6G Applications..... | 2,3 |
| 220-260 GHz Up-converters for 5G/6G Applications | 4 |

Fullband 75-500 GHz Up /Down Converter Pairs

| | |
|---|-----|
| 75-220 GHz Linear Up-converters and Downconverters... .. | 5,6 |
| 170-500 GHz Linear Up-converters and Downconverters... .. | 7,8 |

670 GHz Transmitter/Receiver Pair

| | |
|--|---|
| 670 GHz Linear Up-converter and Downconverter for automotive radar applications..... | 9 |
|--|---|

D Band (126-182 GHz) FMCW Radar Front End Module

| | |
|---|----|
| 126-182 GHz FMCW Radar Transceiver Module with 2 additional receivers | 10 |
|---|----|

Multifunction Converter Modules 110-330 GHz

| | |
|--|-------|
| Converters for spectrum analysis, noise figure testing and block upconverter functions | 11,12 |
|--|-------|

Waveguide Active Multipliers / Source Modules

| | |
|---|----|
| Active Multipliers / Extender Modules for Signal Generators | 13 |
|---|----|

Amplifiers – Low Noise 50 - 350 GHz

| | |
|---------------------------------------|-------|
| Low Noise Amplifiers 50-350 GHz | 14,15 |
|---------------------------------------|-------|

Mixers – 50 - 500 GHz

| | |
|-----------------------------|----|
| Balanced, Fundamental | 16 |
| Subharmonic, n = 2 | 17 |
| Harmonic..... | 18 |

Mixer Preamplifiers – 183 GHz Broadband Radiometer Module

| | |
|---|-------|
| Low noise broadband integrated mixer-amplifier module with state-of-art performance | 19,20 |
|---|-------|

Contents Page 2 of 2

Waveguide Interconnections

| | |
|---|-------|
| Precision Waveguide Straight Sections | 21,22 |
| Precision Waveguide Transitions | 23 |
| Precision Waveguide Bends | 24,25 |
| Precision Waveguide Twists | 26 |

Waveguide Couplers

| | |
|--|----|
| Waveguide Directional Couplers 50-500 GHz..... | 27 |
|--|----|

Waveguide Isolators

| | |
|-------------------------------------|----|
| Waveguide Isolators 50-400 GHz..... | 28 |
|-------------------------------------|----|

Waveguide Filters

| | |
|--|----|
| Custom Filters Lowpass / Bandpass..... | 28 |
| Custom Filters Highpass..... | 31 |

Antennas

| | |
|---------------------------------|----|
| Waveguide Pyramidal Horns | 32 |
| Waveguide Diagonal Horns | 31 |
| Waveguide Lens Horns..... | 33 |

Near Field Probes for Antenna Testing

| | |
|---------------------------------------|----|
| Millimeter/THz Near Feld Probes | 34 |
|---------------------------------------|----|

Millimeter Wave Noise Sources

| | |
|---|----|
| Millimeter Noise Sources 40-170 GHz | 35 |
|---|----|

Noise Figure Downconverters * See also Multifunction Converter Modules pgs.11-12

| | |
|---|----|
| Noise Figure Downconverters 40-170 GHz..... | 36 |
|---|----|

Cryogenic Primary Noise Standard

| | |
|--|----|
| Cryogenic Primary Noise Standard 18-500 GHz..... | 37 |
|--|----|

92-110 GHz SSB Up/Down Converters

General Features

- 6G broadband communications and antenna test range applications
- Extend signal generators/spectrum analyzers or VNA's to mm-wave and THz
- Coverage 75 - 670 GHz in standard and custom bands
- Extend VNA's without direct LO/IF access
- Synchronous frequency and swept operation
- Single Sideband (SSB) versions eliminate image response
- Rugged screened enclosures machined from solid



Fig 1 92-110 GHz SSB Upconverter / Downconverter Pair

Specifications

| Model | THZBUC-10NB-SSB** | THZBDC-10NB-SSB** |
|-------------------------------------|--------------------|-------------------------|
| Input/Output Frequency (GHz) | 92-110 | 92-110 |
| Input RF Frequency (GHz) | 2-20 | 2-20 |
| Input LO Range (GHz) | Internal | Internal |
| Upconverter Power Output (dBm) | +18 typical | - |
| Upconverter Gain (dB) | > 20 dB typical | - |
| Downconverter SSB Noise Figure (dB) | - | < 7.0 typical |
| Downconverter Conversion Gain (dB) | - | 20.0 typical |
| LO /IF Connectors | SMA/K (F) | SMA/K (F) |
| RF Connector | WR10 ; UG387/U-M | WR10 ; UG387/U-M |
| Dimensions (mm) | 145 x 230 x 60 | 100 x 200 x 60 |
| DC Power (external PSU) | 15V 2A | 15V 1.5A |

Notes

1. **Compatible with Signal Generators, Desktop & Portable VNAs up to 40 GHz
2. Full band converters are available with external LO +10 to +13 dBm
3. Upconverter / Downconverter pair measures S21 (transmission) phase and amplitude
4. Reference oscillator input 10 MHz or 100 MHz for synchronization to external equipment
5. Other frequency ranges up to 1 THz on request
6. **How to make a request:** choose Model, or state frequency range, required interfaces, email to: sales@vivatethz.com

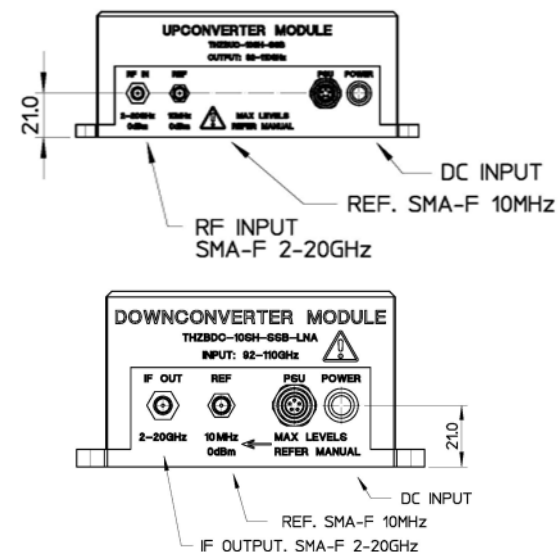

Fig 2 Converter Interfaces

220-260 GHz Down Converters for 5G/6G Applications

General Features

- 5G/6G broadband communications and antenna test range applications
- State-of-the-art noise figure
- Extend signal generators/spectrum analyzers or VNA's to mm-wave and THz
- Coverage 75 - 670 GHz in standard and custom bands
- Extend VNA's without direct LO/IF access
- Synchronous frequency and swept operation with VNA
- Single Sideband (SSB) versions eliminate image response (option)
- Rugged screened enclosures machined from solid

Specifications

| Model | THZBDC-03NB** | THZBDC-03NB-LNA** |
|-------------------------------------|-----------------|----------------------|
| Input Frequency (GHz) | 220-260 | 220-260 |
| Output RF Frequency (GHz) | 0.1-20 | 0.1-20 |
| Input LO (GHz) | Internal, 10.0 | Internal, 10.0 |
| Upconverter Power Output (dBm) | N/A | N/A |
| Upconverter Gain (dB) | N/A | N/A |
| Downconverter DSB Noise Figure (dB) | < 18.0 typical | < 10.0 typical w/LNA |
| Downconverter Conversion Gain (dB) | 10 -15 typical | 25 typical |
| Input 1 dB GCP (dBm) | -10 typical | -30 typical |
| Ext LO / IF Connectors | SMA/K (F) | SMA/K (F) |
| RF Input Connector | WR03; UG387/U-M | WR03; UG387/U-M |
| Dimensions (mm) | 145 x 230 x 60 | 145 x 230 x 60 |
| AC Power Supply (external PSU) | 110-240 VAC | 110-240 VAC |



Fig 1: 220-260 GHz Downconverter Model THZBDC-03



Fig 2: 220-260 GHz Downconverter Rear

220-260 GHz Down Converters for 5G/6G cont'd

Notes

1. **Compatible with Signal Generators and VNAs up to 40 GHz, eg. Keysight / R & S etc.
2. Internal or external Local Oscillator, standard level +10 to +13 dBm
3. Downconverter is shown, a compatible up-converter is available
4. Reference oscillator input 10 MHz as standard for synchronization to external equipment
5. Other frequency ranges up to 1 THz on request
6. Dimensions, specifications and photos are subject to change
7. **How to make a request:** choose Model, or state frequency range, required interfaces, email to: sales@vivatechthz.com

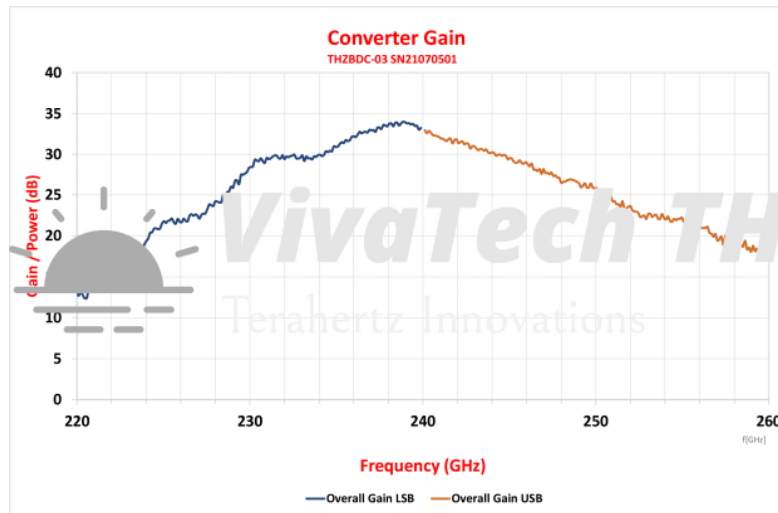

Fig 3 220-260 GHz Downconverter Gain

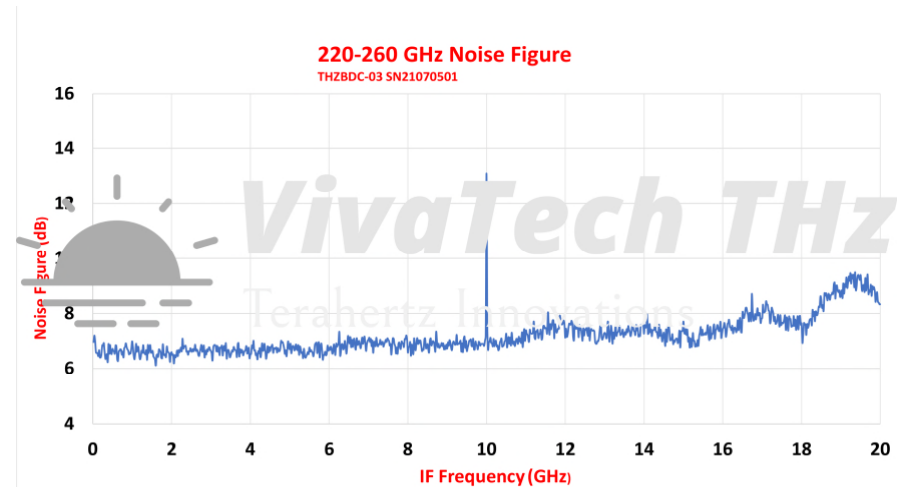

Fig 4 220-260 GHz Downconverter Noise Figure

220-260 GHz Up Converters for 5G/6G

General Features

- 5G/6G broadband communications and antenna test range applications
- Extend signal generators/spectrum analyzers or VNA's to mm-wave and THz
- Coverage 75 - 670 GHz in standard and custom bands
- Extend VNA's without direct LO/IF access
- Synchronous frequency and swept operation with VNA
- Single Sideband (SSB) versions eliminate image response (option)
- Rugged screened enclosures machined from solid

Specifications

| Model | THZBUC-03NB** | THZBUC-03NB-PA** |
|-------------------------------------|-----------------|------------------|
| Output Frequency (GHz) | 220-260 | 220-260 |
| Input RF Frequency (GHz) | 0.1-20 | 0.1-20 |
| Input LO (GHz) | Internal, 10.00 | Internal, 10.00 |
| Upconverter Power Output (dBm) | -25 to -35 | -5 to -10 |
| Upconverter Conversion Loss (dB) | 25 - 35 | 10 - 15 |
| Downconverter DSB Noise Figure (dB) | N/A | N/A |
| Downconverter Conversion Gain (dB) | N/A | N/A |
| Input 1 dB GCP (dBm) | -10 typical | -10 typical |
| Ext LO / IF Connectors | SMA/K (F) | SMA/K (F) |
| RF Input Connector | WR03; UG387/U-M | WR03; UG387/U-M |
| Dimensions (mm) | 145 x 230 x 60 | 145 x 230 x 60 |
| AC Power Supply (external PSU) | 110-240 VAC | 110-240 VAC |



Figure 1 THZBUC-03NB Upconverter

Notes

1. **Compatible with arbitrary waveform generators, signal generators, VNAs up to 40 GHz, eg. Keysight / R & S etc.
2. Internal or external Local Oscillator, standard level +10 to + 13 dBm
3. Upconverter / Downconverter pair measures S21 amplitude & phase
4. Reference oscillator input 10 MHz for synchronization
4. Other frequency ranges up to 1 THz on request
5. Dimensions, specifications and photos are subject to change
6. **How to make a request:** choose Model, or state frequency range, required interfaces, email to: sales@vivatechthz.com

Fullband 75-500 GHz Up/Downconverters

General Features

- Full band coverage from 75 – 500 GHz
- Broadband output power
- Upconverter / Downconverter Pairs with Linear Operation
- High sensitivity receivers
- 5G/6G communications research



Fig 1 110-330 GHz Upconverter



Fig 2 110-330 GHz Downconverter

Specifications (75-220 GHz)

| Model | THZBUC-10 | THZBDC-10 | THZBUC-06 | THZBDC-06 | THZBUC-05 | THZBDC-05 |
|--------------------------------|-----------------|-----------------|-----------------|-----------------|-----------------|-----------------|
| FUNCTION | UPCONVERTER | DOWNCONVERTER | UPCONVERTER | DOWNCONVERTER | UPCONVERTER | DOWNCONVERTER |
| RF Frequency (GHz) | 75-110 | 75-110 | 110-170 | 110-170 | 140-220 | 140-220 |
| RF Power Output (dBm) | +18 typical | - | -15 typical | - | -15 typical | - |
| RF Input Maximum (dBm) | - | -20 | - | -15 | - | -15 |
| IF Input Frequency (GHz) | 0.1-18 | - | 0.1-20 | - | 0.1-20 | - |
| IF Input at saturation (dBm) | 10 | - | -5 | - | -5 | - |
| IF Output Frequency (GHz) | - | 0.1-18 | - | 0.1-20 | - | 0.1-20 |
| Conversion Gain, (dB) | 20 typical | 20 typical | 20 typical | 20 typical | 20.0 typical | 20.0 typical |
| Noise Figure (dB), DSB typical | - | < 7.5 | - | 10-12 | - | 10-12 |
| LO Frequency (GHz) @ +13 dBm | 12.5-18.33 | 12.5-18.33 | 9.17-14.17 | 9.17-14.17 | 11.66-18.33 | 11.66-18.3 |
| LO /IF Connector | 2 X SMA/K (F) | 2 X SMA/K (F) | 2 X SMA/K (F) | 2 X SMA/K (F) | 2 X SMA/K (F) | 2 X SMA/K (F) |
| RF Connector | WR10, UG387/U-M | WR10, UG387/U-M | WR06, UG387/U-M | WR06, UG387/U-M | WR05, UG387/U-M | WR05, UG387/U-M |

Notes

1. Module dimensions 70 x 100 x 180 mm (3 Channel THZBUC and THZBDC) excluding fixings (TBC)
2. Test data: Upconverter - power output and spectrum, downconverter - gain and noise figure
3. DSB operation; SSB options to order
4. Option: internal oscillator with 10 MHz or 100 MHz synchronization
5. Optional: RF input LNA and output PA to customer specifications; consult factory
6. **How to make a request:** choose Model, or state full specifications, required interfaces, email to: sales@vivatechthz.com

Test Data Models THZBUC-06/ THZBDC-06

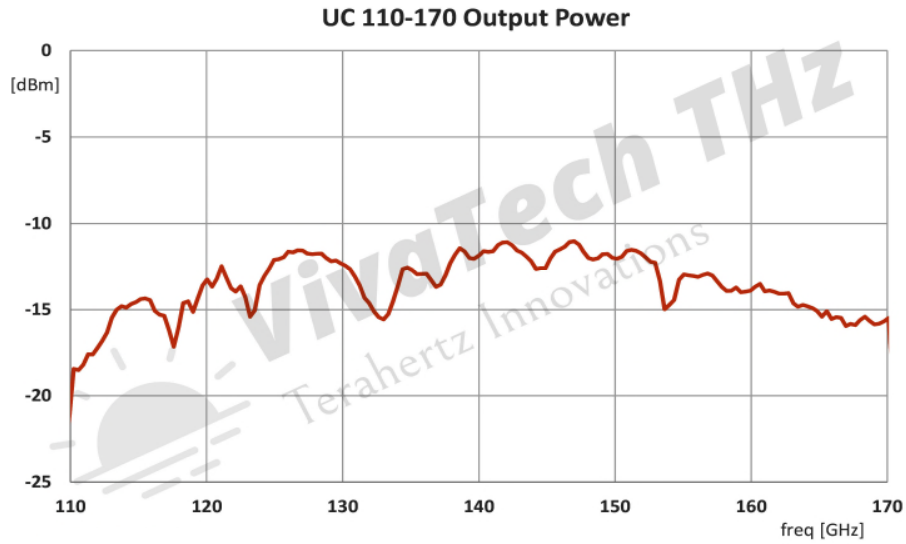

Fig 3 110-170 GHz Upconverter Output Power

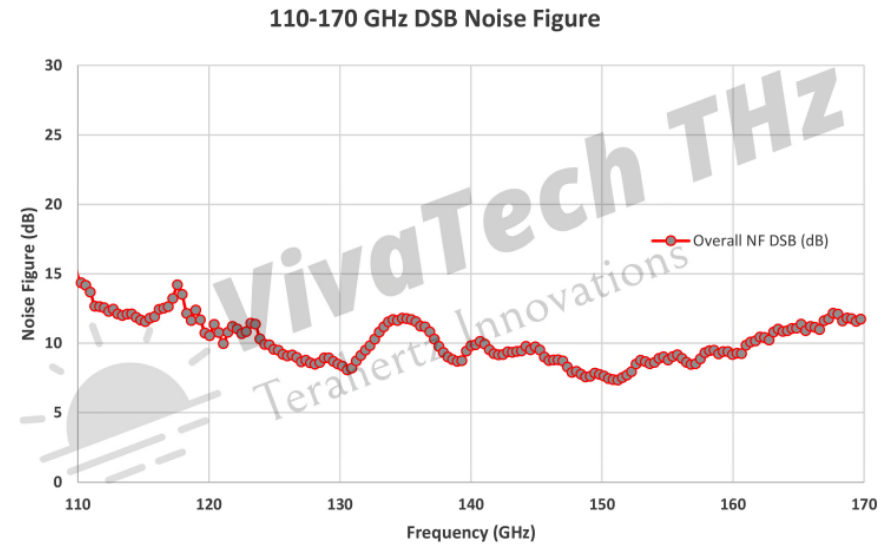

Fig 4 110-170 GHz Downconverter Noise Figure

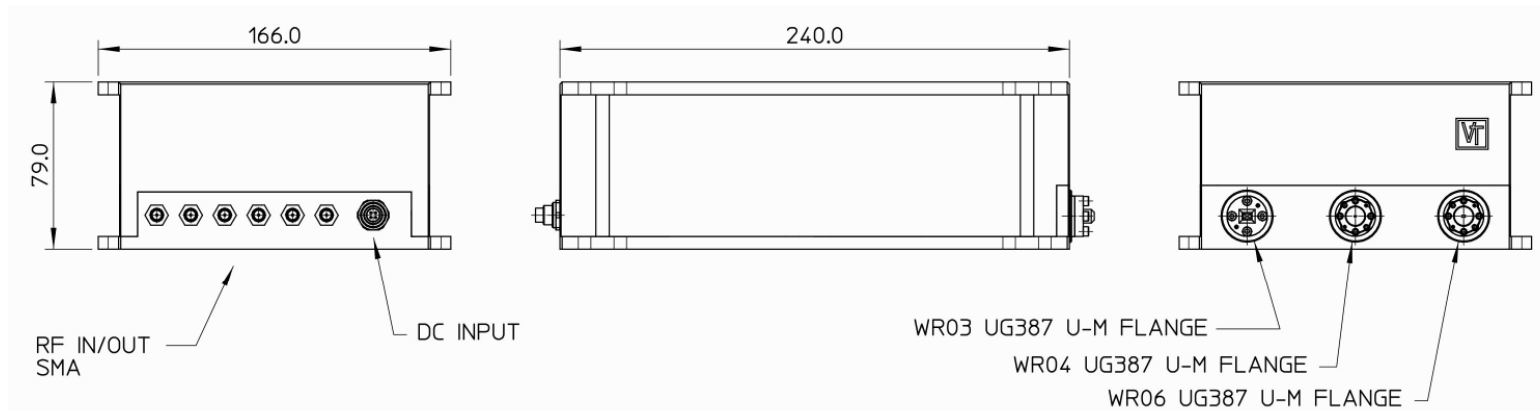

Fig 5 110-330 GHz Converter Module

Fullband 75-500 GHz Up/Downconverters

General Features

- Full band coverage from 75-500 GHz
- Broadband output power
- Linear operation
- High sensitivity receivers
- 5G/6G communications research

Specifications (170-500 GHz)

| Model | THZBUC-04 | THZBDC-04 | THZBUC-03 | THZBDC-03 | THZBUC-2.2 | THZBDC-2.2 |
|---------------------------------------|--------------------|----------------------|--------------------|----------------------|--------------------|----------------------|
| FUNCTION | UPCONVERTER | DOWNCONVERTER | UPCONVERTER | DOWNCONVERTER | UPCONVERTER | DOWNCONVERTER |
| RF Frequency (GHz) | 170-260 | 170-260 | 220-330 | 220-330 | 330-500 | 330-500 |
| RF Power Output (dBm) | -14 to -20 typical | - | -15 typical | - | -20 to -30 typical | - |
| RF Input Maximum (dBm) | - | -15 | - | -15 | - | -15 |
| IF Input Frequency (GHz) | 0.1-20 | - | 0.1-20 | - | 0.1-20 | - |
| IF Input at saturation (dBm) | -5 | - | -5 | - | -5 | - |
| IF Output Frequency (GHz) | - | 0.1-20 | - | 0.1-20 | - | 0.1-20 |
| Conversion Gain, (dB) | 20 typical | 10 typical | 20.0 typical | 10.0 typical | 20.0 typical | 10 typical |
| Noise Figure (dB), DSB typical | - | 12-15 | - | 12-15 | - | 15-20 |
| LO Frequency (GHz) @ +13 dBm | 14.17-21.67 | 14.17-21.67 | 10.83-13.75 | 10.83-13.75 | 13.75-20.83 | 13.75-20.83 |
| LO /IF Connector | 2 X SMA/K (F) | 2 X SMA/K (F) | 2 X SMA/K (F) | 2 X SMA/K (F) | 2 X SMA/K (F) | 2 X SMA/K (F) |
| RF Connector | WR04, UG387/U-M | WR04, UG387/U-M | WR03, UG387/U-M | WR03, UG387/U-M | WR2.2, UG387/U-M | WR2.2, UG387/U-M |

Notes

1. Module dimensions 70 x 100 x 180 mm (3 Channel THZBUC and THZBDC) excluding fixings (TBC)
2. Test data: Upconverter - power output and spectrum, downconverter - gain and noise figure
3. DSB operation; SSB options to order
4. Option: internal oscillator with 10 MHz or 100 MHz synchronization
5. Optional: RF input LNA and output PA to customer specifications; consult factory 6. **How to make a request:** choose Model, or state full specifications, required interfaces, email to: sales@vivatechthz.com

Test Data Models THZBUC/BDC-04 & THZBUC/BDC-03

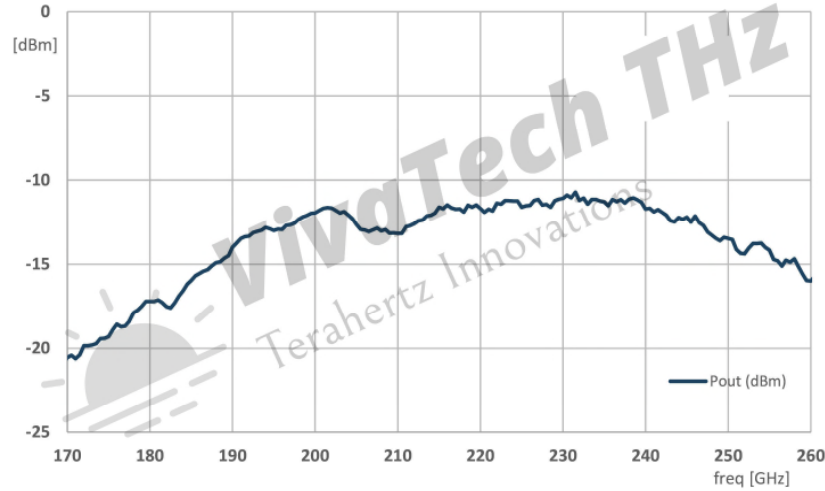

Fig 6 170-260 GHz Upconverter Output Power

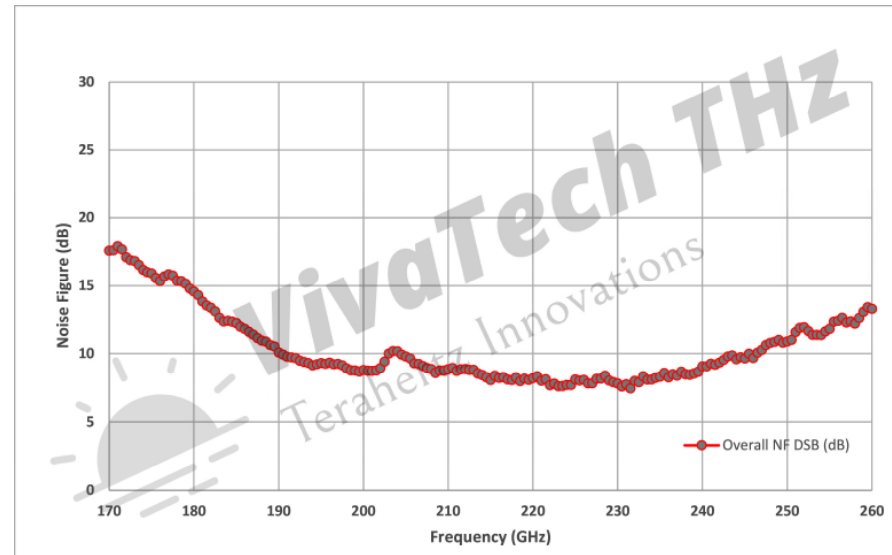

Fig 7 170-260 GHz Downconverter Noise Figure

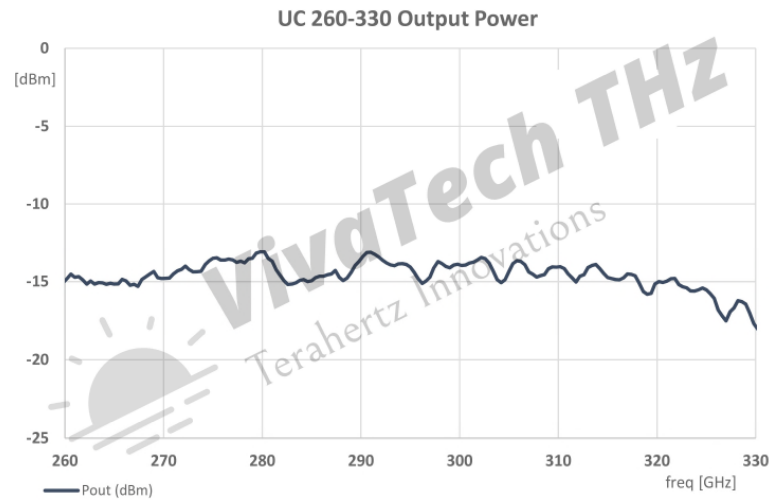

Fig 8 260-330 GHz Upconverter Output Power

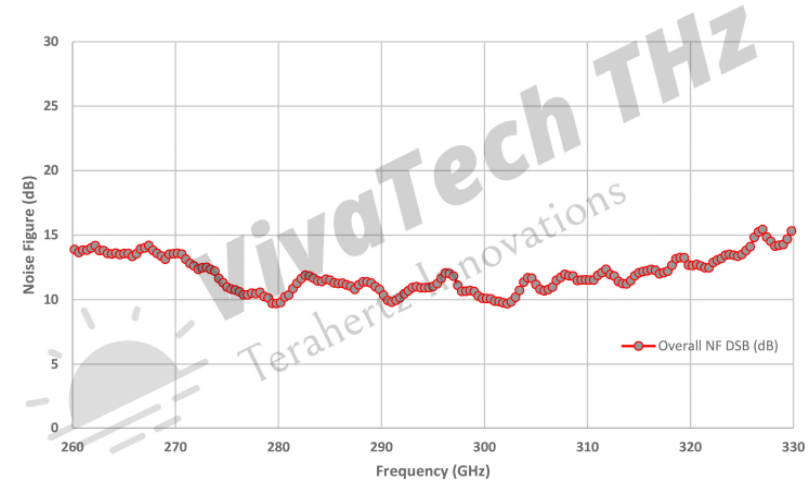

Fig 9 260-330 GHz Downconverter Noise Figure

670 GHz Transmitter / Receiver Pair Fieldfox

General Features

- 650-675 GHz Transmitter / Receiver Converters for automotive FMCW radar
- Extend signal generators/spectrum analyzers or VNA's to mm-wave and THz
- Noise figure 14 dB typical, TX power -10 dBm dynamic range > 100 dB @ 10 Hz IF
- Extend any 20 GHz VNA without direct LO/IF access by linear converters
- Synchronous frequency and swept operation
- Single Sideband (SSB) versions eliminate image response
- Rugged screened enclosures machined from solid

Specifications

| Model | THZBUC-1.5NB** | THZBDC-1.5NB** |
|-------------------------------------|------------------|------------------|
| Input/Output Frequency (GHz) | 656-672 | 656-672 |
| Input/Output RF Frequency (GHz) | 4-20 | 4-20 |
| Input LO Range (GHz) | Internal | Internal |
| Upconverter Power Output (dBm) | -10 typical | - |
| Upconverter Gain (dB) | > 10 dB typical | - |
| Downconverter SSB Noise Figure (dB) | - | < 15.0 typical |
| Downconverter Conversion Gain, dB | - | 10.0 typical |
| LO /IF Connectors | SMA/K (F) | SMA/K (F) |
| RF Connector | WR1.5; UG387/U-M | WR1.5; UG387/U-M |
| Dimensions (mm) | 145 x 230 x 60 | 100 x 200 x 60 |
| DC Power (external PSU) | 15V 2A | 15V 1.5A |

Notes

1. **Compatible with Signal Generators, Desktop & Portable VNAs up to 40 GHz
-developed for Keysight Fieldfox 20 GHz portable VNA Model N9918A, N9950A
2. Upconverter / Downconverter pair measures S21 (transmission) phase and amplitude
3. Reference oscillator input 10 MHz or 100 MHz for synchronization to external equipment
4. Other frequency ranges up to 1 THz on request
5. Shown with optional 670 GHz Potter type feedhorn
6. **How to make a request:** choose Model, or state frequency range, required interfaces, email to: sales@vivatechthz.com



Fig 1 670 GHz Upconverter / Downconverter Pair

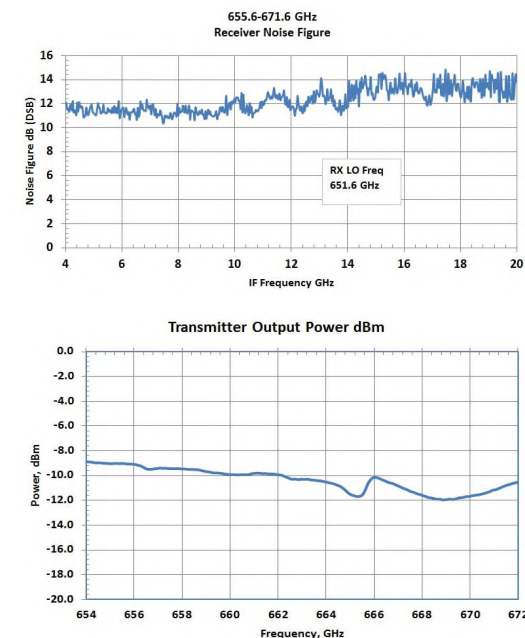

Fig 2 Noise Figure / Output Power

D Band 126-182 GHz FMCW Radar Module

General Features

- Frequency coverage: 126-182 GHz
- Co Planar Waveguide Transceiver with 2 additional receivers
- Custom Antenna & Interface Options
- 56 GHz sweep bandwidth achieving < 3 mm range resolution
- Applications ; non destructive testing, radars
- Use as direct source or VNA module

Specifications

| Model | Frequency Band (GHz) | Transmit Power typical (dBm) | Receiver Noise Figure (dB) | Waveguide (WR) | Standard Flanges * |
|------------|----------------------|------------------------------|----------------------------|----------------|--------------------|
| THZFCW-06S | 126-182 | -10 | 20.0 | WR 6.5 | UG 387/U-M |

*Notes

1. ** With 3 port WR6.5 standard flange adapter
2. Model shown with 3 port waveguide adapter and horn antennas
3. Interface ; Single DC supply 24 V, control USB-C, or Power Over Ethernet
4. Flexible & custom control software interface
5. FMCW sweep rate 1 KHz maximum @ full bandwidth
6. **How to make a request**, specify accessories if required, & email to: sales@vivatechthz.com
7. *Subject to review : photo and data non contractual



Figure 1 D Band FMCW 3-port Transceiver Module



Figure 2 3 port Waveguide Manifold

THz MultiFunction Converter Modules

General Features

- Extend signal generators/spectrum analyzers or VNA's to mm-wave and THz
- Measure Noise Figure with compatible instruments
- Block Up/Downconverter function with external sources
- Frequency range 75-500 GHz in full-band and narrow band options
- Optional internal local oscillator
- Single Sideband (SSB) versions eliminate image response (Option)
- Rugged screened enclosures machined from solid

Outline Specifications

| Model | THZBDC-06NF/UC | THZBDC-03NF/UC |
|-------------------------------------|-------------------------|-----------------------|
| Input Frequency (GHz) | 110-170 | 220-330 |
| Conversion Loss (dB), SSB typical | < 10.0 | < 14.0 |
| Input LO Range (GHz)* | 6.875-10.62/13.75-21.25 | 9.17-14.17/18.33-27.5 |
| IF Range Block Converter Mode (GHz) | > 13.5 | > 18 |
| Input 1 dB GCP (dBm) | -5 typical | -5 typical |
| IF Range S/A Mode | 15 KHz to 2 GHz | 15 KHz to 2 GHz |
| RF Input Damage Level (dBm) | > 10 | > 10 |
| Operating Temperature (deg C) | 20 to 30 | 20 to 30 |
| LO / IF Connectors | SMA/2.92mm K (F) | SMA/2.92 mm K (F) |
| RF Connector | WR6.5 ; UG387/U-M | WR3.4 ; UG387/U-M |
| Dimensions (mm) | 200 x 150 x 100 | 200 x 150 x 100 |
| AC Power Supply (external PSU) | 110-240 VAC | 110-240 VAC |

Notes

1. Compatible with Spectrum and Signal Analyzers eg. Keysight, R & S etc. DANL -140 dBm (1Hz) typical.
2. Internal or external Local Oscillator, standard level +10 to +13 dBm
3. *Low LO range spectrum analyzer; high LO range Upconverter / Downconverter mode
4. Dimensions, data, photographs are non-contractual and subject to revision 5. **How to make a request:** choose Model, or state required specifications, email to: sales@vivatechthz.com



Fig 1 : Converter Model THZBDC-XX



Fig 2 : Converter (Internal Local Oscillator Option)

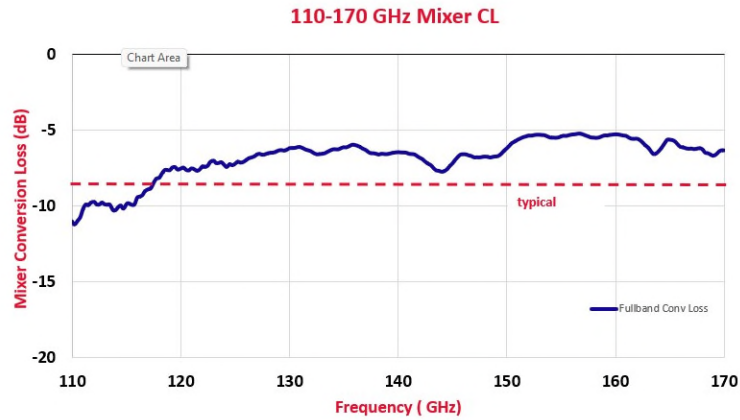

Fig 3 : 110-170 GHz Intrinsic Mixer Conversion Loss (SSB)

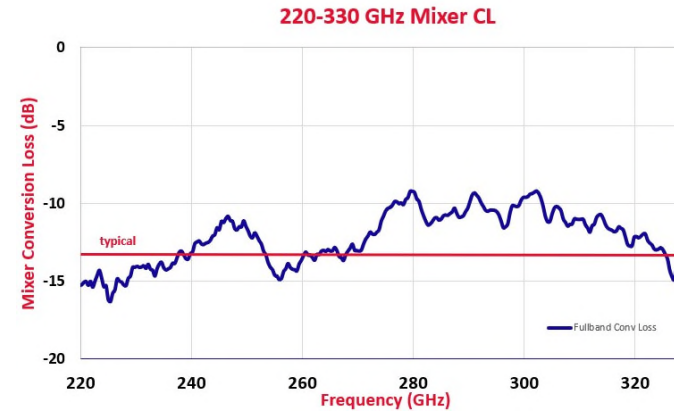

Fig 4 : 220-330 GHz Intrinsic Mixer Conversion Loss (SSB)

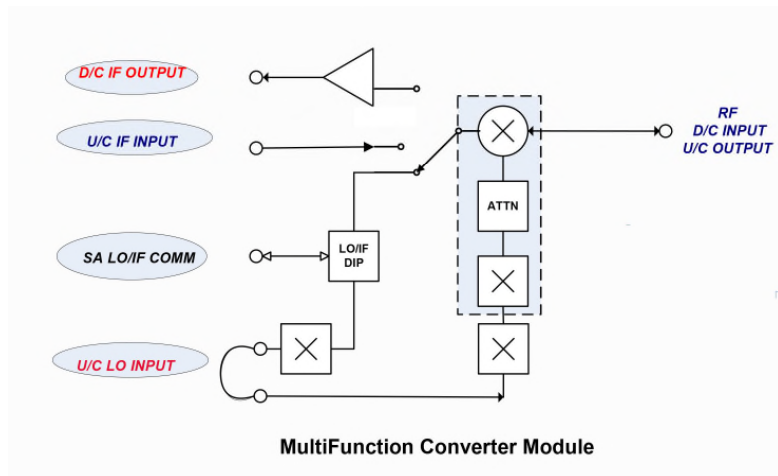

Fig 5 : Functional Schematic

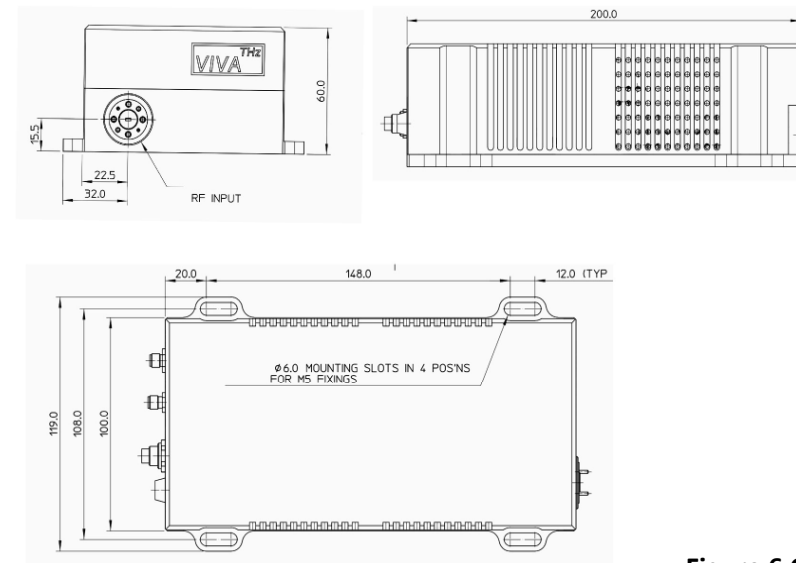

Figure 6 Outline

Waveguide Active Multipliers

General Features

- Plug'n Play: just add DC power and RF microwave input
- Coverage: 33 – 500 GHz
- Standard waveguide full-band & narrow-band
- Ideal signal generator or frequency extender
- High output power
- Flat frequency response
- Optional output isolators (up to 220 GHz)

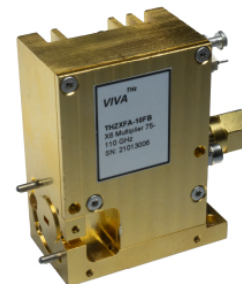

Figure 1 THZXFA-08/10FB

Specifications

| Model | Output Frequency (GHz) | Output Waveguide, Flange | Input Frequency (GHz) | Output Power (dBm) (min, typical) |
|--------------------|------------------------|--------------------------|-----------------------|-----------------------------------|
| THZXFA-12FB* | 60 – 90 | WR 12, UG387/U | 10.0-15.0 | +15, +17 |
| THZXFA-12FBH* | 60 – 90 | WR 12, UG387/U | 10.0-15.0 | +20, +23 typical |
| THZXFA-10FBH | 75 – 110 | WR 10, UG387/U-M | 12.50 – 18.33 | +13, +16 |
| THZXFA-08FB | 90 – 140 | WR 08, UG387/U-M | 15.00 – 23.30 | +10 min, +13 typical |
| THZXFA-06FB | 110 – 170 | WR 06, UG387/U-M | 9.17 – 14.17 | +6 min, +10 typical |
| THZXFA-05FB | 140 – 220 | WR 05, UG387/U-M | 11.66 – 18.34 | +4 typical |
| THZXFA-03FBH | 220 – 330 | WR 03, UG387/U-M | 12.20 – 18.10 | +3 typical |
| THZXFA-2.2FB | 325 – 500 | WR 2.2, UG387/U-M | 9.02 – 13.89 | -10, -8 |

Notes

1. RF input power: +7 to +10 dBm ; customization available
2. Harmonic and spurious: < 20 dBc typical
3. DC: +7 to +9 VDC, < 1 A typical
4. Input connector: SMA (F) or K (F)
5. **How to make a request:** specify Model above, or desired specifications, isolator if required ; email to: sales@vivatechthz.com
6. *Data and outlines are non-contractual and are subject to change*

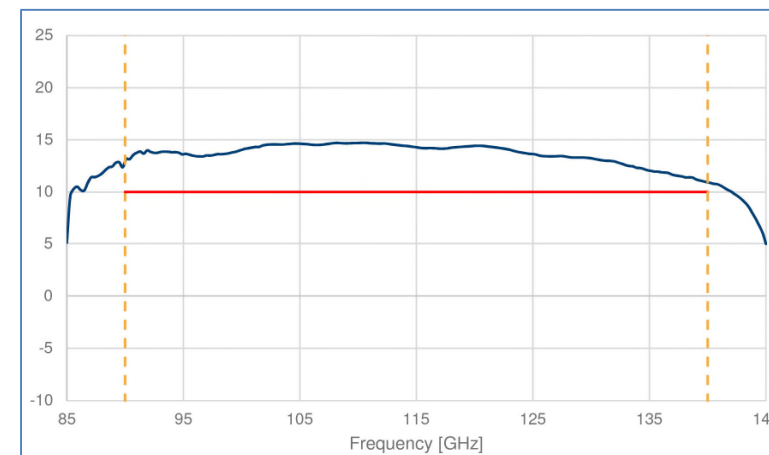

Figure 2 THZXFA-08FB Output Power

Waveguide Amplifiers - Low Noise

General Features

- Frequency coverage: 50 – 350 GHz
- Full band and narrow band
- Lowest Available Noise Figure
- High P-1dB
- Low Power Consumption

Specifications

| Model | Frequency (GHz) | Gain (dB), typical | Noise Figure, dB typical | Waveguide | Flange |
|---------------------|------------------|--------------------|--------------------------|--------------|-------------------|
| THZLNA-12FB | 60 – 90 | 15 | < 5.0 | WR 12 | UG 387/U-M |
| THZLNA-10FB | 75 - 110 | 18 | < 3.5 | WR 10 | UG 387/U-M |
| THZLNA-10FBH | 75 – 110 | 40 | < 3.5 | WR 10 | UG 387/U-M |
| THZLNA-06FB | 110 - 170 | 18 | < 5.0 | WR6.5 | UG 387/U-M |
| THZLNA-06FBH | 110 - 170 | 35 | < 5.0 | WR6.5 | UG 387/U-M |
| THZLNA-05FB | 140 – 220 | 20 | < 6.0 | WR 05 | UG 387/U-M |
| THZLNA-04NB | 210 - 260 | 18 | < 7.5 | WR 04 | UG 387/U-M |
| THZLNA-03/2.8NB | 250 - 350 | 25 | < 12 | WR 03/2.8 | UG 387/U-M |

Notes

1. Test Data: Gain or S parameters, noise figure
2. DC +5 V, < 100 mA typical
3. **How to make a request:** select one of the Models above, or provide specifications to sales@vivatechthz.com



Figure 1 110-170 GHz High Gain LNA

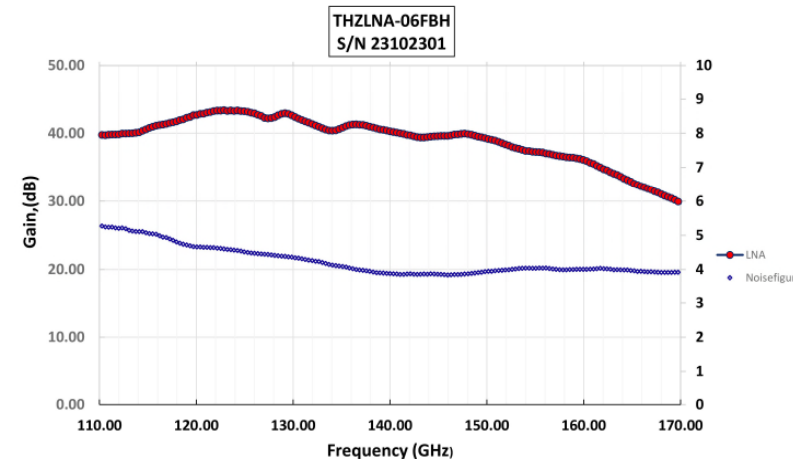

Figure 2 110-170 GHz Gain and Noise Figure

Waveguide Amplifiers - Low Noise contd

Test Data THZLNA-03/2.8 250-350 GHz

- Frequency coverage: 250 – 330 GHz (WR03)
- Frequency coverage: 250 - 350 (WR2.8)
- Lowest Available Noise Figure
- High P-1dB
- Low Power Consumption

S Parameters & Gain Compression



Figure 1 THZLNA-03/2.8NB 250-350 GHz LNA

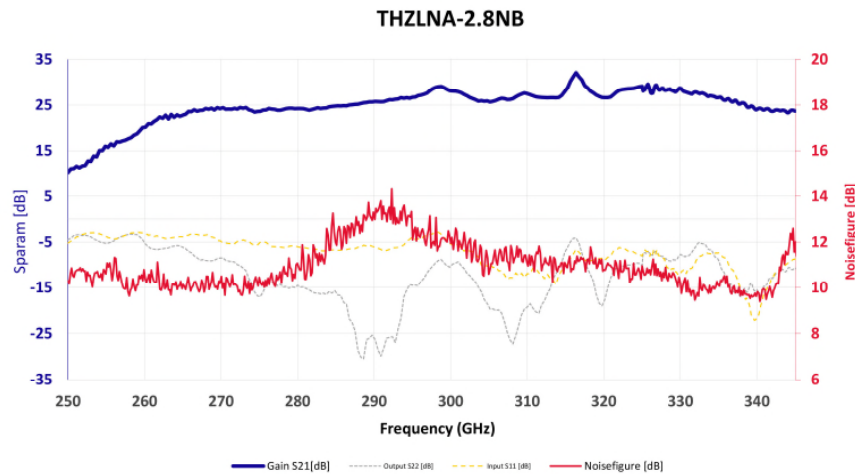

Figure 2 THZLNA-03/2.8NB 250-350 GHz LNA

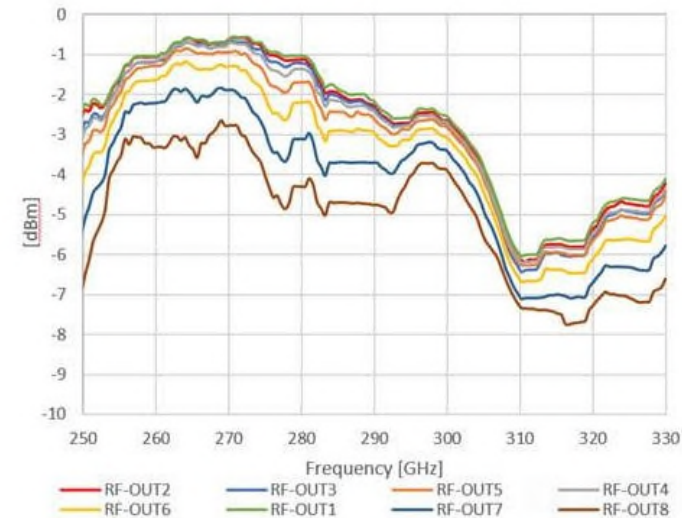

Figure 3 Gain Compression

Waveguide Fundamental Balanced Mixers

General Features

- Frequency coverage: 50 – 140 GHz
- Waveguide full bandwidth RF/LO as standard
- Zero bias, with LO +10 to +13 dBm
- Low conversion loss
- IF to > 20 GHz

Specifications

| Model | RF /LO Frequency (GHz) | Conversion Loss (dB) ⁻¹ | IF Frequency (GHz) max ⁻³ | Input RF _{MAX} (dBm) | Waveguides, Flange |
|----------|------------------------|------------------------------------|--------------------------------------|-------------------------------|--------------------|
| THZBM-15 | 50 – 75 | 7 typical, 10 max | 18 | 13 | WR 15, UG385/U |
| THZBM-12 | 60 – 90 | 7 typical, 10 max | 18 | 13 | WR 12, UG387/U-M |
| THZBM-10 | 75 – 110 | 7 typical, 10 max | 18 | 13 | WR 10, UG387/U-M |
| THZBM-08 | 90 – 140 | 8 typical, 12 max | 18 | 13 | WR 08, UG387/U-M |

Notes

1. Conversion loss, LO @ +13 dBm, IF DC - 18 GHz (IF can extend to 35 GHz with increased loss)
2. Option: combined mixer / LO amplifier units with low LO (0 to +3 dBm typical); send request
3. IF bandwidths typically > 35 GHz with fixed LO. (See also Note 1)
4. IF connector SMA-F/K-F.
5. **How to make a request:** specify Model or waveguide sizes, RF / IF/LO frequency range, LO power, conversion loss, and email to: sales@vivatechthz.com



Figure 1 Full Band Fundamental Balanced Mixers

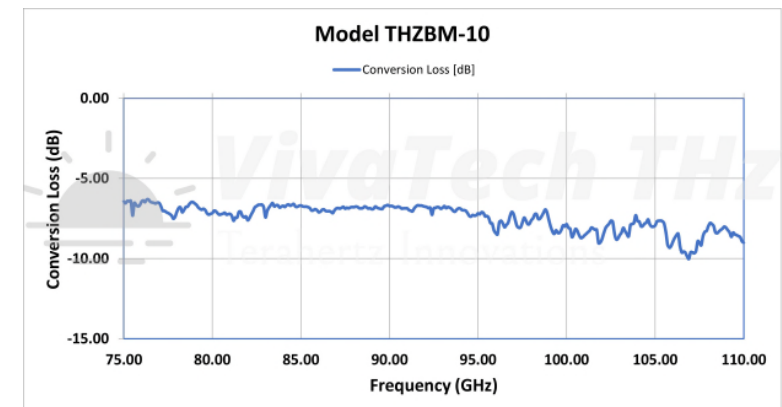

Figure 2 Typical Conversion Loss THZBM-10

Fullband Subharmonic Mixers

General Features

- Frequency coverage: 110 - 350 GHz
- Waveguide full bandwidths up to 330 GHz
- Local Oscillator Frequency = ½ RF
- LO Power +7 to +10 dBm
- Low conversion loss
- IF > 20 GHz

Specifications

| Model | RF Frequency (GHz) | LO Frequency (GHz) | Conversion Loss (dB) ⁻¹ | IF Range (GHz) ⁻³ | RF/LO Waveguide |
|--------------|--------------------|--------------------|------------------------------------|------------------------------|----------------------|
| THZSHM-06 | 110-170 | 55-85 | 10 typical | 0.1-20 | WR 06/12, UG387/U-M |
| THZSHM-04 | 170-260 | 85-130 | 10 typical | 0.1-20 | WR 04/08, UG387/U-M |
| THZSHM-03 | 220-330 | 110-165 | 12 typical | 0.1-40 | WR 03/06, UG387/U-M |
| THZSHM-2.8NB | 300-350 | 160-175 | 15 typical | 0.1-20 | WR 2.8/06, UG387/U-M |



Figure 1 THZSHM-06 110-170 GHz

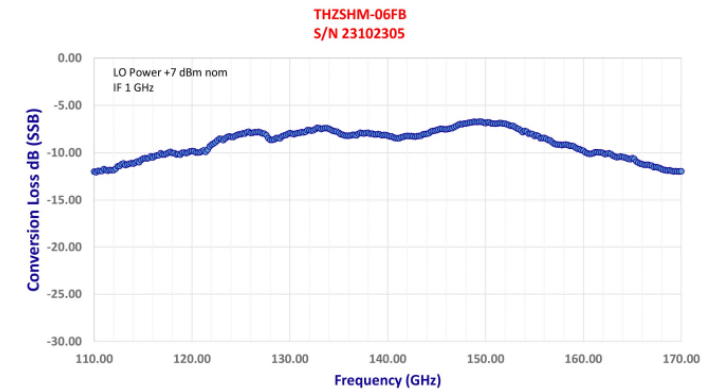

Figure 2 Typical Conversion Loss THZSHM-06

Notes

1. Conversion loss, DSB, with LO optimized @ +10 dBm typical
2. Option: combined mixer / LO units; send request
3. IF bandwidths > 20 with variable LO. (IF extends to 40 GHz with fixed LO, send request)
4. IF connector SMA-F/K-F
5. **How to make a request:** specify Model and RF, IF, LO frequency range, LO power, conversion loss, and email to: sales@vivatechthz.com

Full Band Waveguide Harmonic Mixers

General Features

- Frequency coverage: 75 – 330 GHz
- Waveguide full bandwidth as standard
- Zero bias, common or separate LO / IF ports
- General purpose frequency extension for Spectrum Analyzers
- Even mixing harmonics

Specifications

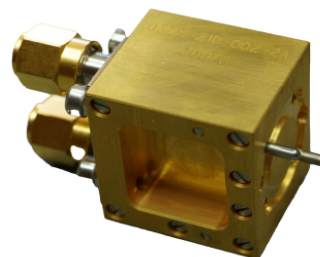
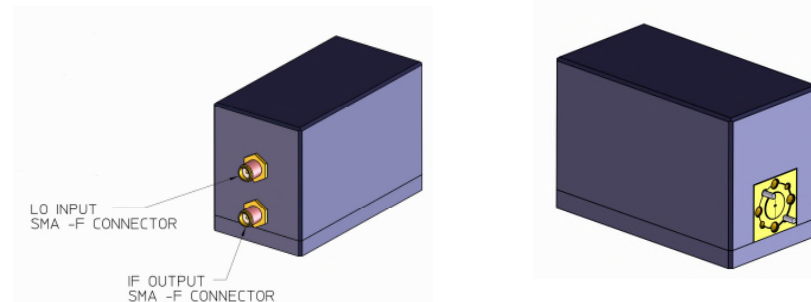

Figure 1 3-port Waveguide Harmonic Mixer



| RF Frequency (GHz) | Model | Conversion Loss (dB) ⁻¹ | LO Frequency (GHz) Maximum | RF _{MAX} (dBm) | Waveguide |
|--------------------|--------------------|------------------------------------|----------------------------|-------------------------|--------------------------|
| 75 – 110 | THZW HM-10 | 20 typical | 9.37-13.75 | +15 | WR 10, UG 387/U-M |
| 75 – 110 | THZW HM-10P | 20 typical | 9.37-13.75 | +15 | WR 10, UG 387/U-M |
| 90 – 140 | THZW HM-08 | 30 to 35 | 18 | +3 | WR 08, UG 387/U-M |
| 110 – 170 | THZW HM-06 | 25 typical, 35 max | 20 | +3 | WR 06, UG 387/U-M |
| 140 – 220 | THZW HM-05 | 35 typical | 20 | 0 | WR 05, UG 387/U-M |
| 170 - 260 | THZW HM-04 | 35 to 42 | 18 | 0 | WR 04, UG 387/U-M |
| 220 – 330 | THZW HM-03 | 35 to 40 | 18 | 0 | WR 3.4, UG 387/U-M |

Notes

1. Conversion loss, LO range 8 - 20 GHz @ +13 to +17 dBm, IF DC – 3 GHz; value depends on harmonic number
2. **-P low LO power version, LO +5 to + 10 dBm typical, packaged with internal LO amplifier, +12V DC required**
3. LO/IF bandwidths up to 18 GHz. Common or separate LO/IF ports. No DC bias required
4. External isolators are available up to 325 GHz
5. **How to make a request:** specify model or waveguide sizes, RF/IF/LO frequency range, conversion loss, email to: sales@vivatechthz.com

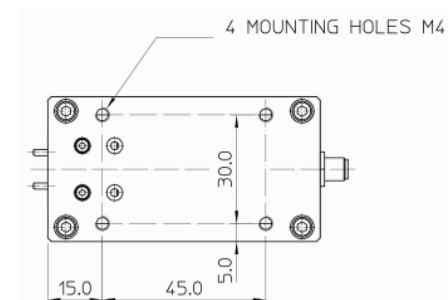

Figure 2 Model THZW HM-10P (DC port not shown)

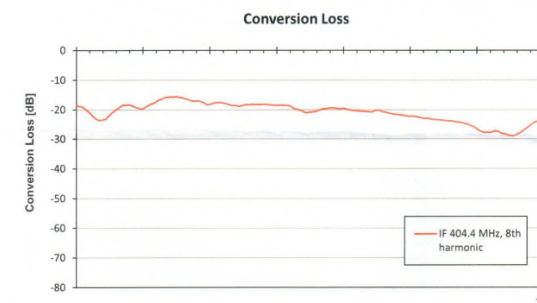

Figure 3 THZW HM-10P Conversion Loss

183 GHz Integrated Mixer Amplifier Module

General Features

- Compact Low Noise Receiver with state-of-art broadband performance
- Broadband DSB (standard) or SSB function (option)
- Radiometer integration, space qualifiable
- External fixed or variable local oscillator
- Optional internal local oscillator
- -20 to + 60 deg temperature range as standard

Outline Specifications

| | |
|--|---------------------------|
| Model | THZSHM-05IF-183-40 |
| Input Frequency (GHz)* | 183 +/- 16.5 |
| Gain (dB), typical, at 25 deg C | 35 |
| Noise Figure (dB) @ 25 deg C | 6.5 typical |
| LO Frequency (GHz)* | 91.65 |
| LO Power (dBm) | + 5 to +7 typical |
| IF Range* | 0.5-20.0 GHz |
| Operating Temperature (deg C) | -20 to +60 |
| IF Connector | 2.92 mm K (F) |
| RF Connector | WR 05 ; UG387/U-M |
| LO Connector | WR 10 ; UG387/U-M |
| Dimensions (mm) | 38 x 19 x 19 |

Notes

1. Developed for low noise receiver/radiometer applications
2. Internal or external Local Oscillator, standard level +5 to + 7 dBm
3. *Other frequencies to order
4. DC +12 V, 150 mA
5. Dimensions, data, photographs are non-contractual and subject to revision

➤ **How to make a request:** choose Model, or state frequency range, required functions & interfaces, email to: sales@vivatechthz.com



Fig 1 : Mixer Pre-amplifier THZSHM-05IF

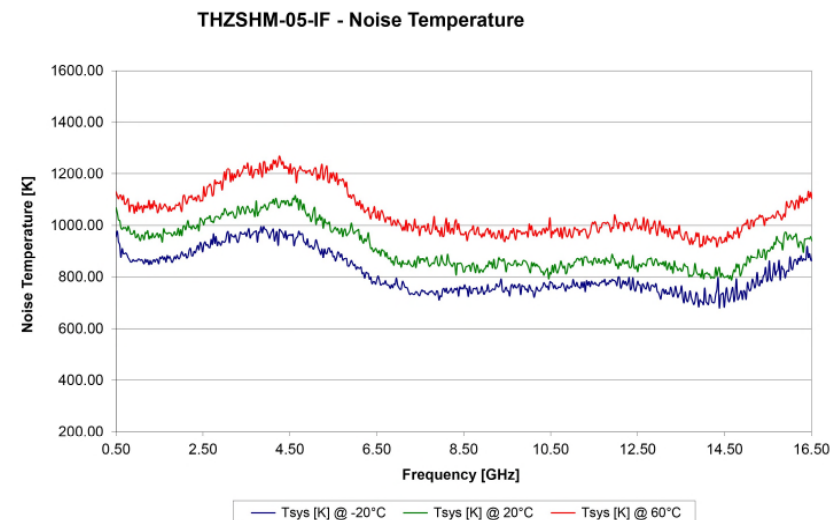

Fig 2 : Noise Figure 183 GHz Mixer Pre-amplifier

183 GHz Receiver Module - continued

Test Data

- Compact Low Noise Receiver with state-of-art broadband performance
- 40 GHz DSB minimum bandwidth
- Radiometer integration, space qualifiable
- External fixed or variable local oscillator
- Optional internal local oscillator
- -20 to + 60 deg temperature range as standard
- Single +12 V DC bias with < 120 mA

Outline Drawing

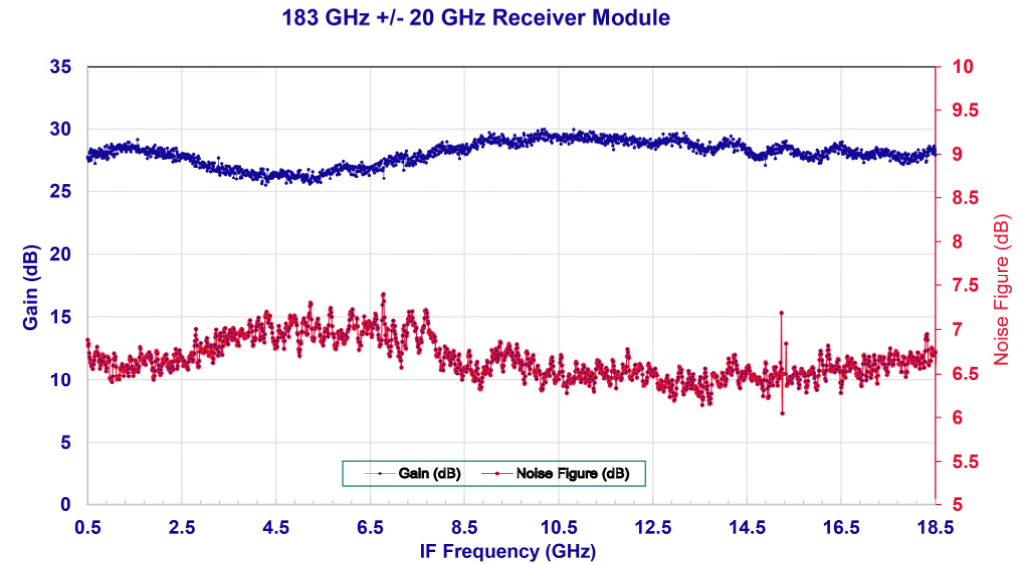
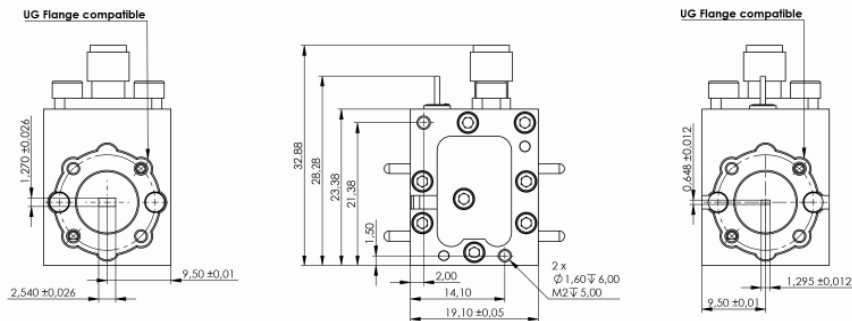

Fig 3 : Gain and Noise Figure 183 GHz Receiver Module

Dimensions, data, photographs are non-contractual and subject to revision

Precision Waveguide Straight Sections 75-1100 GHz

General Features

- Frequency coverage: up to 1.1 THz
- Machined from solid or drawn waveguide*
- High precision
- Custom length
- Lowest loss in industry

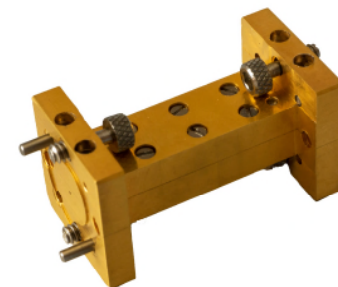

Specifications

| Model | Frequency Range (GHz) | Waveguide Designation | IEEE Waveguide Designation | Standard Flange ⁻² |
|--------------|-------------------------|-----------------------|----------------------------|-------------------------------|
| THZWG-10-xx | 75 – 110 | WR 10 | WM-2540 | UG 387/U-M |
| THZWG-08-xx | 90 – 140 | WR 08 | WM-2022 | UG 387/U-M |
| THZWG-06-xx | 110 – 170 | WR 06 | WM-1651 | UG 387/U-M |
| THZWG-05-xx | 140 – 220 | WR 05 | WM-1295 | UG 387/U-M |
| THZWG-04-xx | 170 – 260 | WR 04 | WM-1092 | UG 387/U-M |
| THZWG-03-xx | 220 – 330 ⁻³ | WR 03 | WM-864 | UG 387/U-M |
| THZWG-2.8-xx | 260 – 400 | WR 2.8 | WM-710 | UG 387/U-M |
| THZWG-2.2-xx | 330 – 500 | WR 2.2 | WM-570 | UG 387/U-M |
| THZWG-1.5-xx | 500 – 750 | WR 1.5 | WM-380 | UG 387/U-M |
| THZWG-1.0-xx | 750 - 1100 | WR 1.0 | WM-250 | UG 387/U-M |

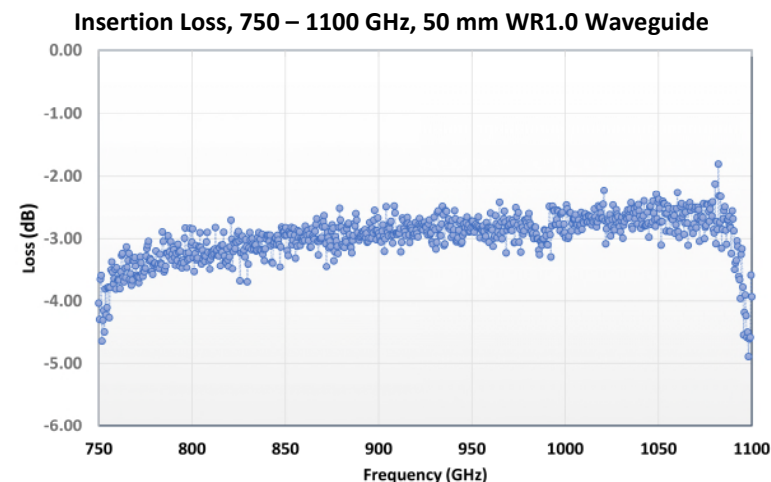

Notes

1. New definitions are in use above 110 GHz, as defined by IEEE standards up to 1.1 THz.
2. *Depends on Model. Above 110 GHz most units (see photo) are machined from solid brass and gold plated.
3. Waveguide WR 03 historically covers 220-325 GHz, the new standard WM-864 covers 220 – 330 GHz.
4. Standard waveguides are 25 mm long, machined from brass and gold plated. Other lengths and materials available to order.
5. **How to make a request:** specify Model number with required length eg. THZWG-03-50 is a WR03/WM-864 straight section of length 50 mm. Email to: sales@vivatechthz.com

Precision Waveguide Straight Sections 75-1100 GHz, contd.

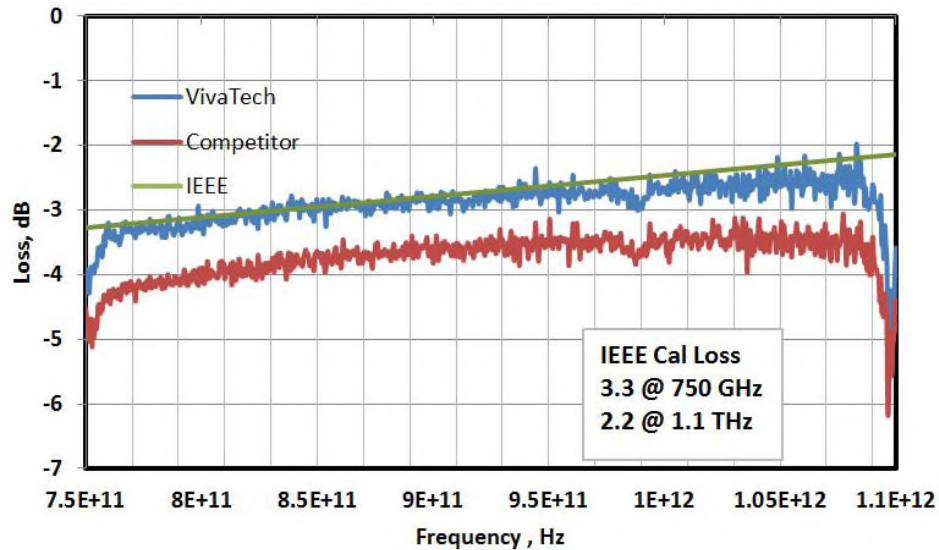

Fig 1 Loss comparisons & IEEE waveguide standard 75-1100 GHz

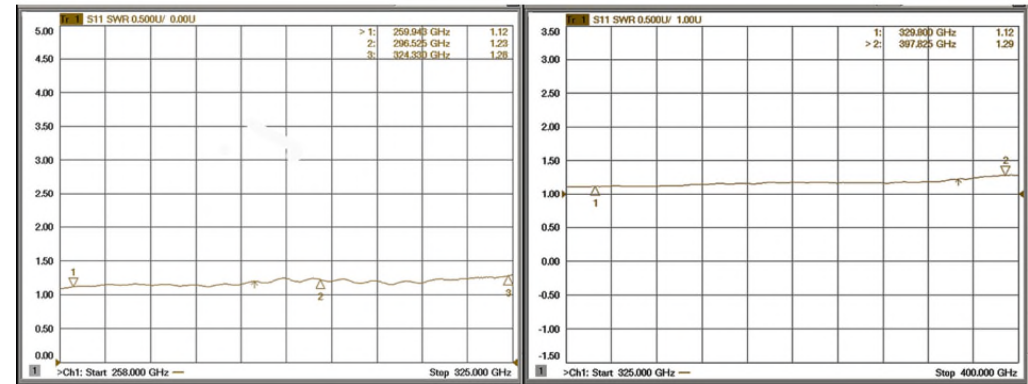

Fig 2 Typical VSWR WR2.8 260-400 GHz

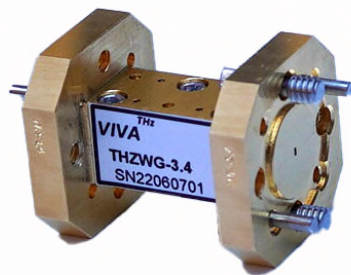
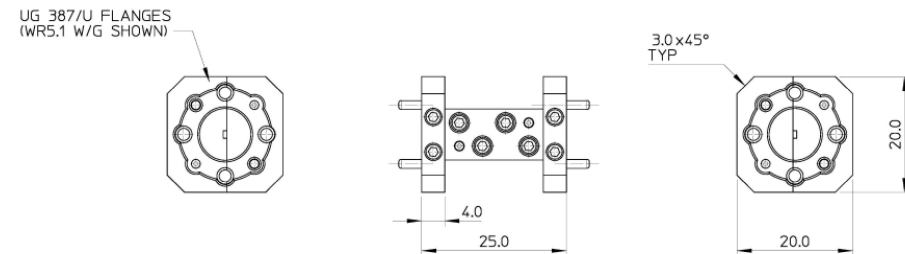

Fig 3 Model THZWG-3.4



| PART No. | DRG No. | TITLE | COMMENT |
|-----------|----------|-------------------------------------|----------|
| THZWG-05 | VT391-01 | WAVEGUIDE STRAIGHT 25mm LONG. WR5.1 | AS DRAWN |
| THZWG-04 | VT391-02 | WAVEGUIDE STRAIGHT 25mm LONG. WR4.3 | |
| THZWG-2.8 | VT391-03 | WAVEGUIDE STRAIGHT 25mm LONG. WR2.8 | |

Fig 4 Outlines Series THZWG-XX

Precision Waveguide Transitions

General Features

- Frequency coverage: up to 500 GHz
- Inter-series adapters
- High precision
- Custom length possible
- Low loss
- Robust versions machined from solid



Figure 1 THZWGTA-10-12

Specifications

| Model Waveguide Transition | Waveguide Port 1 | Frequency Coverage (GHz) | Waveguide Port 2 | Frequency Coverage (GHz) |
|----------------------------|-----------------------|--------------------------|-----------------------|--------------------------|
| THZWGTA-15-12 | WR15 UG385/U | 50 - 75 | WR12 UG387/U-M | 60 - 90 |
| THZWGTA-12-10 | WR12 UG387/U-M | 60 - 90 | WR10 UG387/U-M | 75 - 110 |
| THZWGTA-10-08 | WR10 UG387/U-M | 75 - 110 | WR08 UG387/U-M | 90 - 140 |
| THZWGTA-08-06 | WR08 UG387/U-M | 90 - 140 | WR06 UG387/U-M | 110 - 170 |
| THZWGTA-06-05 | WR06 UG387/U-M | 110 - 170 | WR05 UG387/U-M | 140 - 220 |
| THZWGTA-05-04 | WR05 UG387/U-M | 140 - 220 | WR04 UG387/U-M | 170 - 260 |
| THZWGTA-04-03 | WR04 UG387/U-M | 170 - 260 | WR03 UG387/U-M | 220 - 325 |
| THZWGTA-03-2.8 | WR03 UG387/U-M | 220 - 325 | WR2.8 UG387/U-M | 260 - 400 |
| THZWGTA-2.8-2.2 | WR2.8 UG387/U-M | 260 - 400 | WR2.2 UG387/U-M | 330 - 500 |

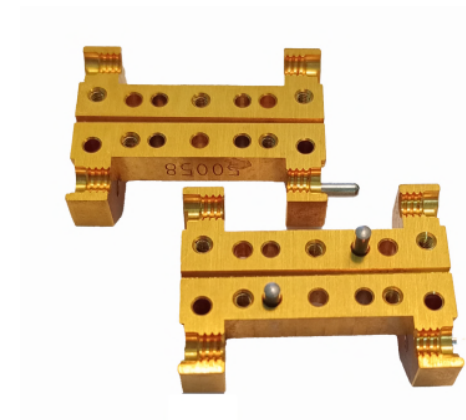

Figure 2 THZWGTA-10-12 internal

Notes

1. Model THZWGTA-15-12 is a waveguide transition between waveguide WR15 and WR12.
2. Transitions between series are formed by precision machined tapers.
3. There are variations in industry 'standard' flanges. Precision flanges have tighter tolerances.
4. Standard waveguide transitions have a length of 25 mm. Models THZWGTA -15-12 and THZWGTA-12-10 have a length of 36 mm. Dimensions are available to order.
5. **How to make a request:** specify Model number, or custom dimensions if required. Email to: sales@vivatechthz.com

Waveguide Bends E and H Plane

General Features

- Frequency coverage: 50 – 1100 GHz
- 90 deg angle as standard
- E or H plane versions
- Precision machined from solid *
- Custom designs



THZWGH-06 90 deg H Plane Bend



THZWGE-1.5 90 deg E Plane Bend

Specifications

| Model | Frequency Range (GHz) | VSWR (typical) | Waveguide (WR) | Flange (Standard) |
|--------------|-----------------------|----------------|----------------|-------------------|
| THZWGE/H-15 | 50 – 75 | < 1.1 | WR 15 | UG385/U |
| THZWGE/H-10 | 75 – 110 | < 1.1 | WR 10 | UG387/U-M |
| THZWGE/H-08 | 90 – 140 | < 1.1 | WR 08 | UG387/U-M |
| THZWGE/H-06 | 110 – 170 | < 1.2 | WR 06 | UG387/U-M |
| THZWGE/H-05 | 140 – 220 | < 1.2 | WR 05 | UG387/U-M |
| THZWGE/H-04 | 170 – 260 | < 1.25 | WR 04 | UG387/U-M |
| THZWGE/H-03 | 225 – 325 | < 1.5 | WR 03 | UG387/U-M |
| THZWGE/H-2.8 | 260 – 400 | < 1.5 | WR 2.8 | UG387/U-M |
| THZWGE/H-2.2 | 330 – 500 | < 1.5 | WR 2.2 | UG387/U-M |
| THZWGE/H-1.5 | 500 – 750 | < 1.75 | WR 1.5 | UG387/U-M |
| THZWGE/H-1.0 | 750 - 1100 | < 1.75 | WR 1.0 | UG387/U-M |

Notes

1. Model THZWGE-XX is an E plane 90 deg bend. Model THZWGH-XX is an H plane 90 deg bend.
2. Flange types above 110 GHz (WR10) may vary. Specify your flange requirement above WR10.
3. Bend material is copper or copper alloy gold plated.
4. * above 110 GHz. Below 110 GHz bends are gold plated copper or silver drawn waveguide.
5. VSWR values are typical based on samples, not tested individually. (Optional test on request)



THZWGE-2.2 90 deg E Plane Bend

Waveguide Bends E and H Plane contd.

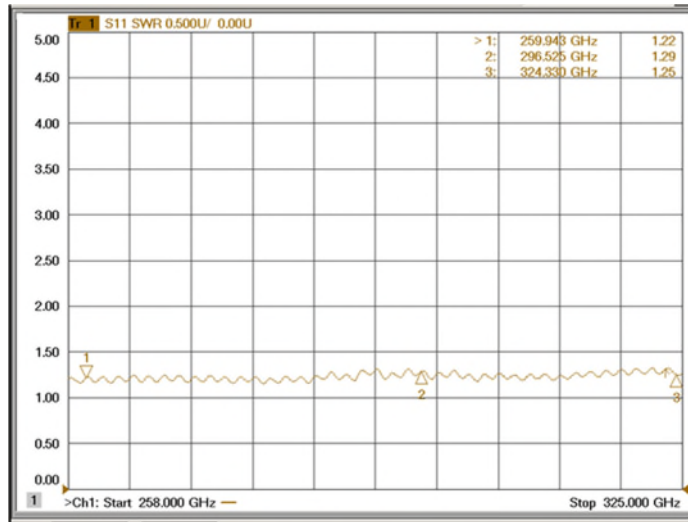

THZWGE-2.8 E Plane Bend VSWR 260-325 GHz

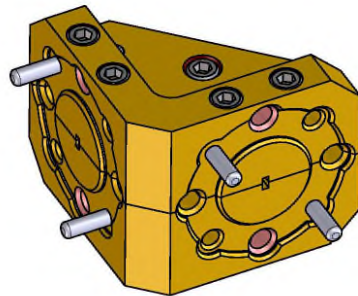

THZWGE/H 90 deg Bends

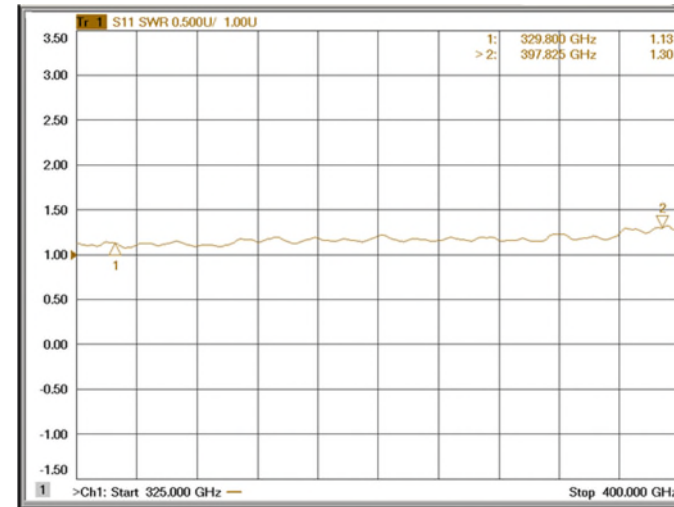

THZWGE-2.8 E Plane Bend VSWR 325-400 GHz

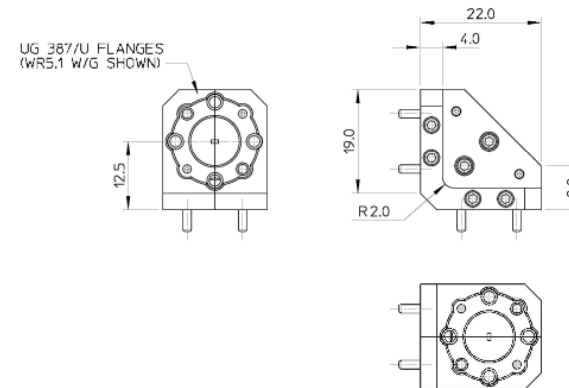

| PART No. | DRG No. | TITLE | COMMENT |
|------------|----------|----------------------------|----------|
| THZWGE-05 | VT400-01 | WAVEGUIDE E-BEND 90° WR5.1 | AS DRAWN |
| THZWGE-04 | VT400-02 | WAVEGUIDE E-BEND 90° WR4.3 | |
| THZWGE-2.8 | VT400-03 | WAVEGUIDE E-BEND 90° WR2.8 | |

THZWGE/H Outline Drawing

Waveguide Twists

General Features

- Frequency coverage: up to 1100 GHz
- High precision
- Custom length possible
- Low loss
- Robust versions machined from solid



Specifications

| Model Twist 90° ** Note 6 | Frequency Coverage (GHz) | Waveguide Designation | New IEEE Waveguide Designation | Standard Flange ⁻² |
|---------------------------------|--------------------------|-----------------------|--------------------------------|-------------------------------|
| THZWGTW-10 | 75 – 110 | WR 10 | WM-2540 | UG 387/U-M |
| THZWGTW-08 | 90 – 140 | WR 08 | WM-2022 | UG 387/U-M |
| THZWGTW-06 | 110 – 170 | WR 06 | WM-1651 | UG 387/U-M |
| THZWGTW-05 | 140 – 220 | WR 05 | WM-1295 | UG 387/U-M |
| THZWGTW-04 | 170 – 260 | WR 04 | WM-1092 | UG 387/U-M |
| THZWGTW-03 | 220 – 330 ⁻³ | WR 03 | WM-864 | UG 387/U-M |
| THZWGTW-2.8 | 260 – 400 | WR 2.8 | WM-710 | UG 387/U-M Precision |
| THZWGTW-2.2 | 330 – 500 | WR 2.2 | WM-570 | UG 387/U-M Precision |
| THZWGTW-1.5 | 500 – 750 | WR 1.5 | WM-380 | UG 387/U-M Precision |
| THZWGTW-1.0 | 750 – 1100 | WR 1.0 | WM-250 | UG 387/U-M Precision |

Notes

1. New waveguide definitions are also used above 75 GHz, as defined by IEEE.
2. There are variations in industry 'standard' flanges. Precision flanges have tighter tolerances. Specify your needs.
3. Waveguide WR 03 historically covers 220-325 GHz. The new standard WM-864 extends coverage to 220 – 330 GHz.
4. Standard twists have length 25 mm.
5. **'Shim 90 deg twists' with 0.2 mm thickness and reduced loss are available to special order.

How to make a request: specify Model number, or custom dimensions if required. Email to: sales@vivatechthz.com

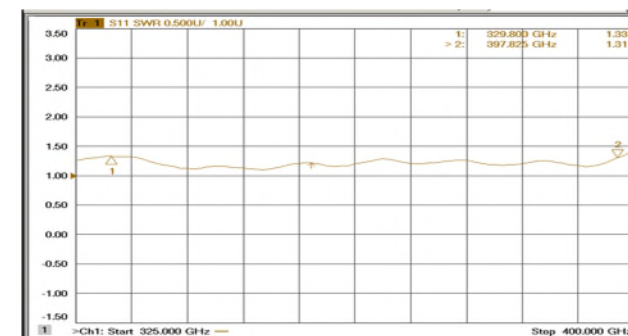
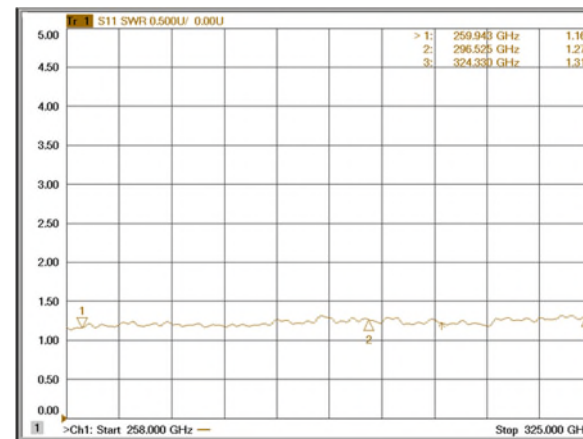

Fig 1 WR2.8 260-400 GHz 90 deg Twist VSWR

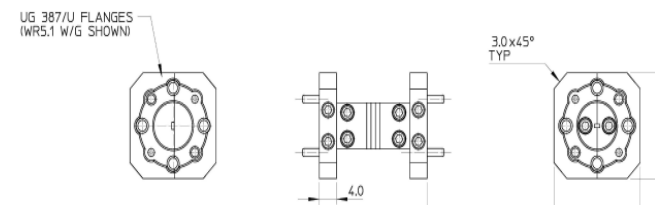

Fig 2 THZWGTW Twist Outline

Waveguide Couplers/ Power Splitters – 50-500 GHz

General Features

- Frequency coverage: 50 – 500 GHz
- Full waveguide bands
- Low loss
- Various directivities
- 3-port or 4-port models
- Fully Calibrated

90-140 GHz 2 way Power Splitter



90-140 GHz 3 dB Power Splitter

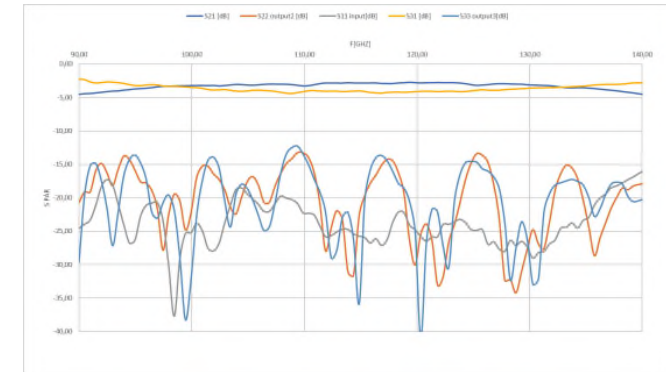

Specifications

| Model | Frequency (GHz) | Insertion Loss, typical (dB) ¹ | Directivity (dB); Typical | Coupling (dB) | Waveguide, Flange |
|---------------|-----------------|---|---------------------------|-----------------------|--------------------|
| THZWGC/PD-15 | 50 – 75 | 0.75 | 35 | | WR 15, UG 385/U |
| THZWGC/PD-10 | 75 – 110 | 0.9 | 35 | | WR 10, UG 387/U-M |
| THZWGC/PD-08 | 90 – 140 | 1.5 | 30 | 3 to 40 ⁻¹ | WR 08, UG 387/U-M |
| THZWGC/PD-06 | 110 – 170 | 1.2 | 25 | | WR 06, UG 387/U-M |
| THZWGC/PD-05 | 140 - 220 | 1.5 | 25 | | WR 05, UG 387/U-M |
| THZWGC/PD-04 | 170 – 260 | 1.7 | 25 | | WR 04, UG 387/U-M |
| THZWGC/PD-03 | 220 – 330 | 2.2 | 25 | | WR 03, UG387/U-M |
| THZWGC/PD-2.2 | 325 - 500 | 3.5 | 30 typical | | WR 2.2, UG 387/U-M |

220-330 GHz 30 dB 3 port coupler

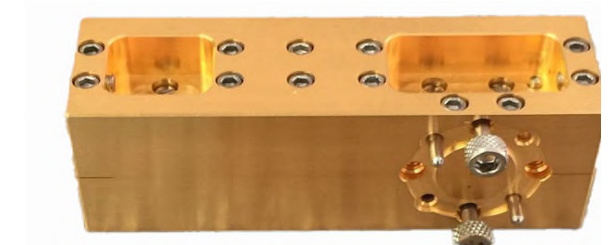

Notes

1. Coupling values and insertion loss depends on the frequency band selected
 2. Dual couplers with internal terminations are available upon request
 3. Insertion loss does not include the coupled power loss
 4. Power dividers (3 dB Hybrid coupler) **specify THZPD-XX** where XX defines the waveguide band
- **How to make a request:** select one of the Models above, or provide specifications and email to: sales@vivatechthz.com

Isolators – 50-400 GHz Full Waveguide Bands

General Features

- Full band coverage
- Compact, low loss
- Lowest insertion loss in industry
- Low VSWR
- High isolation
- Available up to 400 GHz

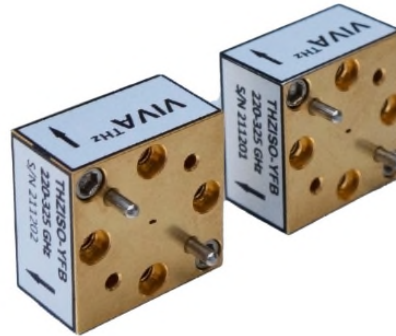

Specifications

| Model | Frequency (GHz) | Insertion Loss (dB); typical, max | Isolation (dB); typical | Waveguide, Flange |
|-------------|-----------------|-----------------------------------|-------------------------|--------------------|
| THZISO-VFB | 50 – 75 | 1.3 | > 20 | WR 15, UG 385/U |
| THZISO-WFB | 75 – 110 | 1.3 | > 20 | WR 10, UG387/U-M |
| THZISO-FFB | 90 – 140 | 1.5 | > 20 | WR 08, UG 387/U-M |
| THZISO-DFB | 110 – 170 | 0.8, 1.3 max | > 20 | WR 06, UG 387/U-M |
| THZISO-GFB | 140 – 220 | 1.7 typical, 2.3 max | > 20 | WR 05, UG 387/U-M |
| THZISO-43FB | 170 – 260 | 1.7 typical, 3.2 max | > 22 | WR4.3, UG 387/U-M |
| THZISO-YFB | 220 - 330 | 2.3 typical, 3.5 max | > 25 | WR 3.4, UG 387/U-M |
| THZISO-28FB | 260 - 400 | 3.8 typical, 5.6 max | > 25 | WR 2.8, UG 387/U-M |

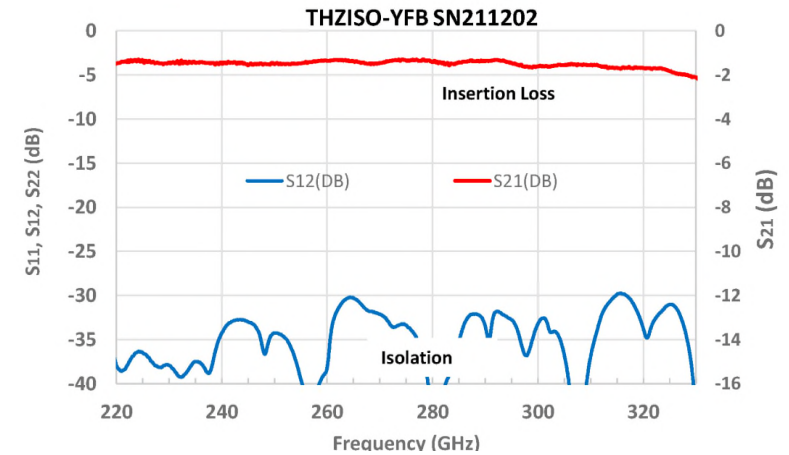

Figure 2 Insertion Loss & Isolation 220-330 GHz

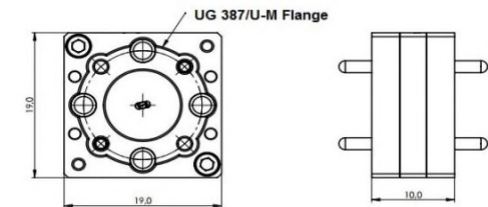

Figure 3 Outline dimensions 19 x 19 x10 mm

Notes:

1. How to make a request: Select a model above, or provide required frequency range, insertion loss, isolation, and waveguide size, send email to: sales@vivatechthz.com
2. These compact isolators offer lower loss than conventional designs
3. **How to make a request:** specify Model number. Email to: sales@vivatechthz.com

Custom Lowpass / Bandpass Filters

General Features

- Frequency coverage: 50 – 220 GHz
- Waveguide standard bands
- Custom rejection characteristics
- Low passband insertion loss

Specifications

| Model | Frequency Band (GHz) | BW ** typical (%) | Passband* Insertion Loss dB typical | Rejection dB typical * | Waveguide (WR) | Standard Flange |
|---------------|----------------------|-------------------|-------------------------------------|------------------------|----------------|-----------------|
| THZLPF/BPF-15 | 50 – 75 | 3-15 | < 1.5-2.0 | 30 - 40 | WR 15 | UG 385/U |
| THZLPF/BPF-10 | 75 - 110 | 3-15 | < 2.0-2.5 | 30 - 40 | WR 10 | UG 387/U-M |
| THZLPF/BPF-08 | 90 - 140 | 3-15 | < 2.0-3.0 | 30 - 40 | WR 08 | UG 387/U-M |
| THZLPF/BPF-06 | 110 - 170 | 5-20 | < 2.5-3.5 | 30 - 40 | WR 06 | UG 387/U-M |
| THZLPF/BPF-05 | 140 – 220 | 5-20 | < 2.5-4.5 | 30 - 40 | WR 05 | UG 387/U-M |
| THZLPF/BPF-04 | 170 – 260 | 5-20 | < 2.5-4.5 | 30 - 40 | WR 04 | UG 387/U-M |
| THZLPF/BPF-03 | 220 - 330 | 5-20 | < 2.5-4.5 | 30 - 40 | WR 03 | UG 387/U-M |

*Notes

1. Model THZLPF-XX is a Low Pass Filter and THZBPF-XX is a Band Pass Filter
2. ** Other values on request
3. *Specification dependent. Predicted performance simulations may be available
4. High Pass Filters up to 500 GHz on request - see [Custom High Pass Filters](#)
5. Material: gold plated brass body and flanges
6. **How to make a request**, select one of Models above, provide specifications and email to: sales@vivatechthz.com

*Subject to review : photo and data non contractual



Figure 1 THZBPF-03 Bandpass Filter

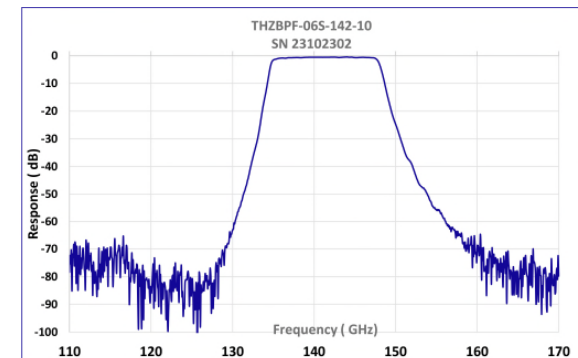

Figure 2 THZBPF-06 135-145 GHz

Custom High Pass Filters

General Features

- Frequency coverage: 50 – 220 GHz
- Waveguide standard bands
- Custom rejection characteristics
- Low passband insertion loss

Specifications

| Model | Frequency Band (GHz) | Cut-off Frequency Fc (GHz) | Rejection dB typical @ Fc*0.95 | Waveguide (WR) | Standard Flange |
|-----------|----------------------|----------------------------|--------------------------------|----------------|-----------------|
| THZHPF-15 | 50 – 75 | Specify | > 40 | WR 15 | UG 385/U |
| THZHPF-10 | 75 - 110 | -- | > 40 | WR 10 | UG 387/U-M |
| THZHPF-08 | 90 - 140 | -- | > 40 | WR 08 | UG 387/U-M |
| THZHPF-06 | 110 - 170 | -- | > 40 | WR 06 | UG 387/U-M |
| THZHPF-05 | 140 – 220 | -- | > 40 | WR 05 | UG 387/U-M |
| THZHPF-04 | 170 – 260 | -- | > 40 | WR 04 | UG 387/U-M |
| THZHPF-03 | 220 - 330 | -- | > 40 | WR 03 | UG 387/U-M |

*Notes

1. Insertion loss < 2 dB typical
2. Predicted performance simulations available
3. Up to 500 GHz on request
4. Material: gold plated brass body and flanges
5. **How to make a request**, select one of Models above, provide full specifications and email to: sales@vivatechthz.com

*Subject to review : photo and data non contractual



Figure 1 Waveguide High Pass Filter

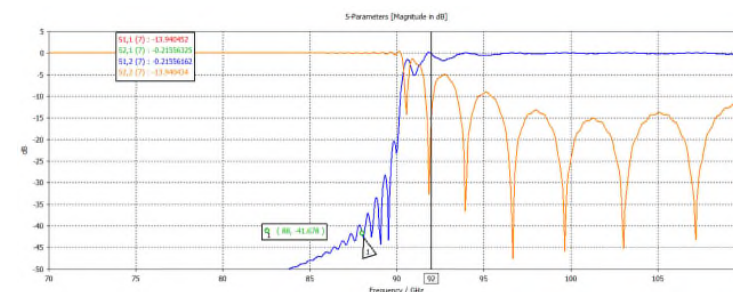

Figure 2 High Pass Filter THZHPF-10 @ 92 GHz

Antennas - Waveguide Pyramidal Horns

General Features

- Frequency coverage: 75 – 1100 GHz
- Broadband with full waveguide bandwidth
- Standard gain horns-preferred standards
- Predictable characteristics
- Solid and robust construction



Fig 1 THZAP-1.5RS

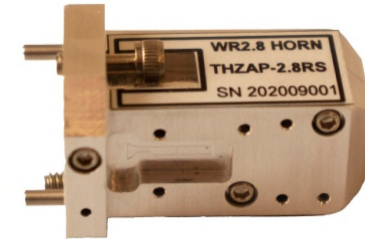

Fig 2 THZAP-2.8RS 260-400 GHz

Specifications

| Model | Frequency (GHz) | Gain (dBi), nominal | VSWR, typical | Waveguide, WR | Standard Flange |
|--------------------|------------------|---------------------|-----------------|---------------|-------------------|
| THZAP-10RS | 75 – 110 | 23.0 | < 1.1 | WR 10 | UG 387/U-M |
| THZAP-08RS | 90 – 140 | 23.0 | < 1.1 | WR 08 | UG 387/U-M |
| THZAP-06RS | 110 – 170 | 23.0 | < 1.1 | WR 06 | UG 387/U-M |
| THZAP-05RS | 140 – 220 | 23.0 | < 1.15 | WR 05 | UG 387/U-M |
| THZAP-04RS | 170 – 260 | 23.0 | < 1.15 | WR 04 | UG 387/U-M |
| THZAP-03RS | 220 – 325 | 23.0 | < 1.15 | WR 03 | UG 387/U-M |
| THZAP-2.8RS | 260 – 400 | 24.0 | < 1.5 | WR 2.8 | UG 387/U-M |
| THZAP-2.2RS | 330 – 500 | 24.0 | < 1.5 | WR 2.2 | UG 387/U-M |
| THZAP-1.5RS | 500 – 750 | 24.0 | < 1.5 | WR 1.5 | UG 387/U-M |
| THZAP-1.0RS | 750 - 1100 | 24.0 | < 1.5 | WR 1.0 | UG 387/U-M |

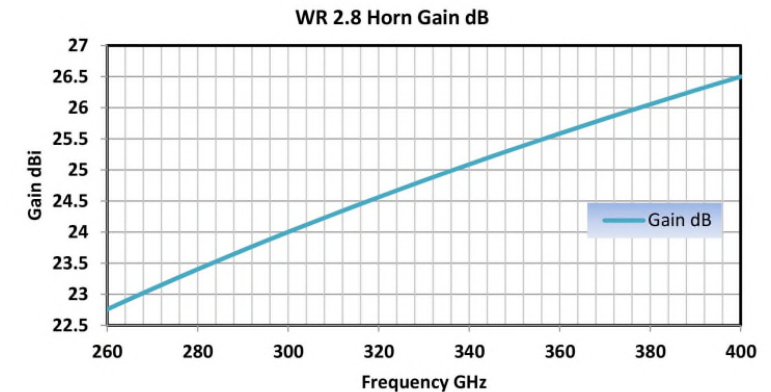

Fig 3 THZAP-2.8RS with 25 dBi gain

Notes

1. Standard horns have 23 -25 dBi gain at mid band. Other values are available to order. Custom antennas are available.
2. Materials : electroformed copper gold plated and gold plated copper alloy or aluminium.
3. VSWR and gain are typical values from sample product, not tested for each individual horn.
4. Pyramidal horns are used as standards since their gain characteristics can be accurately predicted.
5. **How to make a request**, select one of Models above, or provide specifications to: sales@vivatechthz.com

Antennas - Waveguide Diagonal Horn Antennas

General Features

- Frequency coverage: 220 – 1100 GHz
- Broadband with full waveguide bandwidth
- Near Gaussian characteristics
- Solid and robust construction
- Simplified manufacturing



Specifications

Fig 1 500-750 GHz Diagonal Horn Model THZAP-1.5DS

| Model | Frequency (GHz) | Gain (dB) * | HPBW, typical | Waveguide | Flange, anti-cocking type |
|-------------|------------------|-------------|---------------|---------------|---------------------------|
| THZAP-05DS | 140 – 220 | 25.0 | 8 deg | WR 05 | UG 387/U-M |
| THZAP-04DS | 170 – 260 | 25.0 | 8 deg | WR 04 | UG 387/U-M |
| THZAP-03DS | 220 – 325 | 25.5 | 10 deg | WR 3.4 | UG 387/U-M |
| THZAP-2.8DS | 260 – 400 | 25.0 | 8 deg | WR 2.8 | UG 387/U-M |
| THZAP-2.2DS | 330 – 500 | 25.0 | 8 deg | WR 2.2 | UG 387/U-M |
| THZAP-1.5DS | 500 – 750 | 25.0 | 8 deg | WR 1.5 | UG 387/U-M |
| THZAP-1.0DS | 750 - 1100 | 25.0 | 8 deg | WR 1.0 | UG 387/U-M |

Notes

1. Diagonal horns have antenna patterns close to Gaussian beams and are easier to manufacture than corrugated or conical horns.
2. *Standard diagonal horns have 25 dBi gain at mid band. Other gains are available to order.
3. Flange types above 110 GHz (WR10) may vary. Specify your flange requirement above WR10.
4. These models are machined from solid Aluminium.
5. *Product photographs and data are non contractual and subject to review.*
6. **How to make a request**, select one of Models above, or provide specifications to: sales@vivatechthz.com

Antennas - Lens Horn Antennas

General Features

- Frequency coverage: 110 – 500 GHz
- Pencil beam and asymmetric beams
- Radar & Passive Imaging
- OTA Communications
- Custom Designs

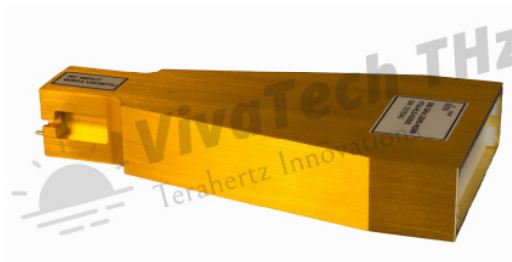
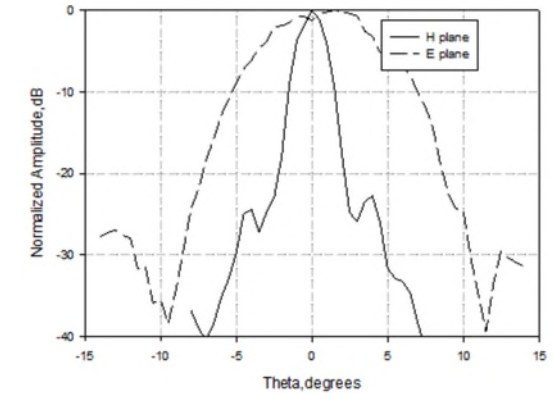

Fig 1 THZHLA-03AB Asymmetric Beam



Specifications

| Model | Frequency (GHz) | Type | Gain (dB) | Beamwidth (E/H) deg ¹ | Waveguide, Flange |
|-------------|-----------------|-------------|-------------|----------------------------------|-------------------|
| THZHLA-10NB | 75 - 110 | Pencil beam | >25 typical | 1-5 | WR10, UG387/U-M |
| THZHLA-10AB | 75 – 110 | Assymetric | custom | 1-5, 10-20 | WR10, UG387/U-M |
| THZHLA-06NB | 110 - 170 | Pencil beam | >25 typical | 1-5 | WR06, UG387/U-M |
| THZHLA-06AB | 110 – 170 | Assymetric | custom | 1-5, 10-20 | WR06, UG387/U-M |
| THZHLA-05NB | 140 – 220 | Pencil beam | >25 typical | 1-5 | WR05, UG387/U-M |
| THZHLA-05AB | 140 – 220 | Assymetric | custom | 1-5, 10-20 | WR05, UG387/U-M |
| THZHLA-03NB | 220 – 325 | Pencil beam | >25 typical | 1-5 | WR03, UG387/U-M |
| THZHLA-03AB | 220 - 325 | Assymetric | custom | 1-5, 10-20 | WR03, UG387/U-M |



Fig 2 THZHLA-03NB Pencil Beam

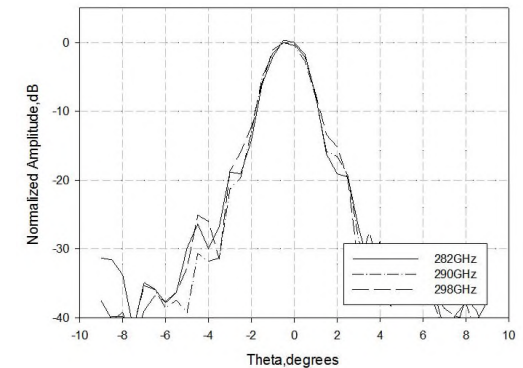

Notes

1. Nominal, mid band, varies with frequency. Other values are available to order.
2. Flange types above 110 GHz (WR10) may vary. Specify your flange requirement above WR10.
3. Other frequency ranges are available to order.
4. Material is copper or copper alloy gold plated, excluding lens.
5. **How to make a request:** Specify center frequency, 3 dB E/H beam width, waveguide size, gain, any other requirements, email to: sales@vivatechthz.com

Near Field Probes – Millimeter / THz

General Features

- Frequency coverage: 75 – 1100 GHz
- Near Field Scanning Applications
- Standard waveguide interfaces
- Quasi-uniform main beam
- Precision machining
- Custom designs



Fig 1 THZWGP-05-100 140-220 GHz

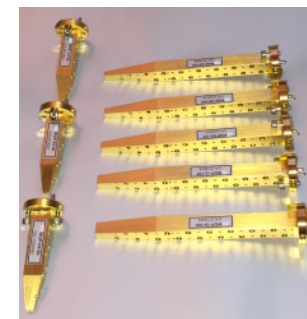

Fig 2 Probe Set 50-500 GHz

Specifications

| Model | Frequency (GHz) | Standard Length, mm | VSWR, typical | Waveguide |
|--------------------|------------------|---------------------|-----------------|--------------|
| THZWGP-10-XX | 75 – 110 | 100.0 | < 1.1 | WR 10 |
| THZWGP-08XX | 90 – 140 | 100.0 | < 1.1 | WR 08 |
| THZWGP-06XX | 110 – 170 | 100.0 | < 1.2 | WR 06 |
| THZWGP-05XX | 140 – 220 | 50.0 | < 1.2 | WR 05 |
| THZWGP-04XX | 170 – 260 | 50.0 | < 1.25 | WR 04 |
| THZWGP-03XX | 220 – 325 | 50.0 | < 1.5 | WR 03 |
| THZWGP-2.8XX | 260 – 400 | 35.0 | < 1.5 | WR 2.8 |
| THZWGP-2.2XX | 330 – 500 | 35.0 | < 1.75 | WR 2.2 |
| THZWGP-1.5XX | 500 – 750 | 35.0 | < 1.75 | WR 1.5 |
| THZWGP-1.0RS | 750 - 1100 | 25.0 | < 1.75 | WR 1.0 |

Notes

1. Suffix – XX denotes length. Standard lengths are shown above. Custom lengths are available.
2. Precision anti-cocking flanges type UG387/U-M are fitted as standard.
3. Probe material is copper or copper alloy gold plated.
4. Probes are tapered to reduce reflections in near field antenna measurements.
5. The chosen length is a compromise between probe loss and potential measurement perturbation.

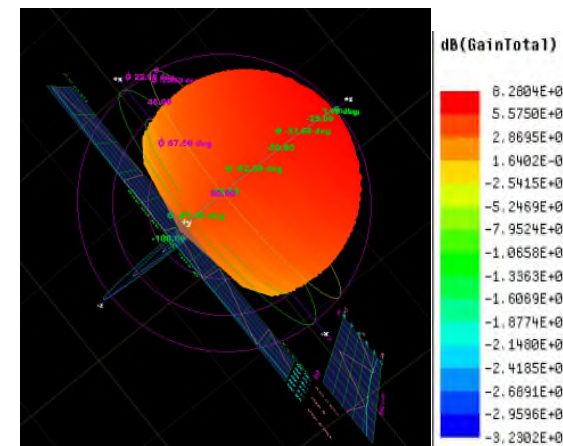

Measured Beam Pattern THZWGP-08-50

Millimeter Wave Noise Sources -Series THZNS-XXFB

General Features

- Full band coverage from 110-170 GHz
- Compatible with standard noise figure meters*
- Use with Noise Test Set Downconverters see 'Noise Figure Downconverters'
- Integrated Isolator
- High ENR with flat response
- Provided with calibration data
- Automatic noise measurements in mm-wave bands

Specifications

| Model | Frequency Range (GHz) | Noise Source ENR (dB) typical | VSWR | Waveguide Interface |
|------------|-----------------------|-------------------------------|------------|---------------------|
| THZNS-19FB | 40 - 60 | 12 +/- 2.5 | 1.5: 1 max | WR 19, UG387/U-M |
| THZNS-15FB | 50 - 75 | 12 +/- 2.5 | 1.5: 1 max | WR 15, UG387/U-M |
| THZNS-12FB | 60 - 90 | 12 +/- 2.5 | 1.5: 1 max | WR 12, UG387/U-M |
| THZNS-10FB | 75 - 110 | 12 +/- 2.5 | 1.5: 1 max | WR 10, UG387/U-M |
| THZNS-08FB | 90 - 140 | 12 +/- 2.5 | 1.5: 1 max | WR 08, UG387/U-M |
| THZNS-06FB | 110 - 170 | 12 +/- 2.5 | 1.5: 1 max | WR 06, UG387/U-M |

Notes

- 1.*Keysight N8975A/B and others
2. Trigger voltage; TTL 1 KHz max
3. DC power; +18 to 28 V < 100 mA typical
4. Stability 0.01 dB/deg C
5. Noise Source is supplied with isolator and calibration data
6. Operating Range 0-30 deg C. Specifications apply at 25 deg C



Figure 1. 110-170 GHz Noise Source with Isolator

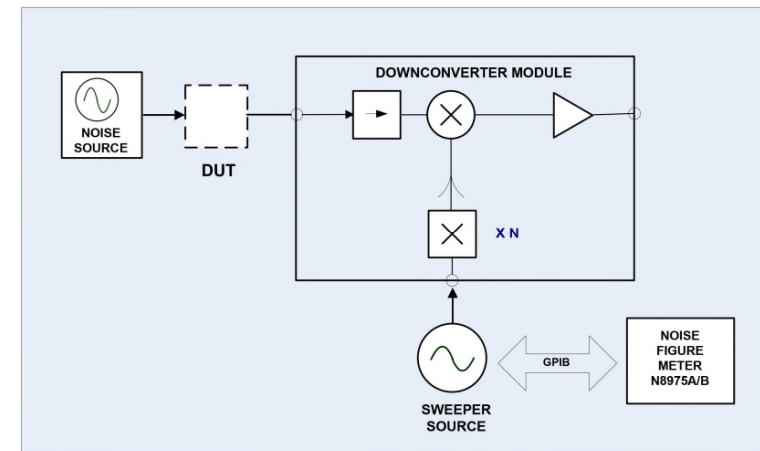

**Figure 2. Noise Test Set Measurement System - Example

Noise Figure Downconverters -Series THZBDC-XXFBE

General Features

- Full band coverage from 40-170 GHz in waveguide bands
- Compatible with noise figure meters and spectrum analyzers*
- Swept frequency measurement
- Compatible solid state noise source provided
- Use with internal spectrum analyzer signal generator**
- Extend noise measurements to mm-wave bands



Specifications

| Model | Frequency Range (GHz) | LO Input Freq (GHz) | Noise Source ENR (dB) typical | Test Range, NF / Gain (dB) | Waveguide Interfaces |
|--------------|-----------------------|---------------------|-------------------------------|--|----------------------|
| THZBDC-19FBE | 40 - 60 | 10.0-15.0 | 13 +/- 1.5 | Noise Figure: 0-20 Gain: -20 to +30 | WR 19, UG383/U-M |
| THZBDC-15FBE | 50 - 75 | 8.33-12.5 | 13 +/- 1.5 | | WR 15, UG385/U |
| THZBDC-12FBE | 60 - 90 | 10.0-15.0 | 13 +/- 1.5 | | WR 12, UG387/U-M |
| THZBDC-10FBE | 75 - 110 | 9.37-13.75 | 12 +/- 1.5 | | WR 10, UG387/U-M |
| THZBDC-08FBE | 90-140 | 7.5-11.67 | 12 +/- 1.5 | | WR 08, UG387/U-M |
| THZBDC-06FBE | 110-170 | 9.17-14.17 | 12 +/- 2.5 | | WR 06, UG387/U-M |

Notes

- 1.*Keysight N8975A/B Noise Figure Meter, various R & S or Keysight Spectrum Analyzers**
2. LO/IF connectors SMA-F
3. IF output 10 MHz - 3 GHz
4. Overall gain 30 dB typical, NF 10 – 15 dB typical
5. DC power: +12 V < 1 A typical (TBC)
6. Noise Source supplied with isolator and calibration data
7. Converter Module 67 x 99 X 180 mm (TBC)

Figure 1. Downconverter Module with Noise Source

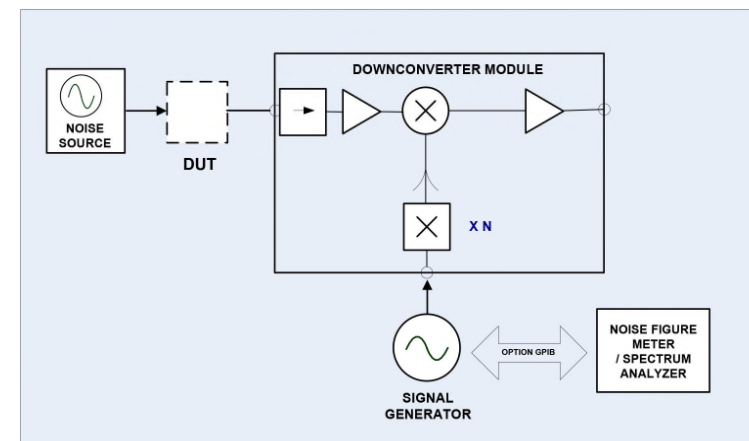

Figure 2. Noise Test Set Measurement System

Cryogenic Primary Noise Standard 18-500 GHz

VivaTech THz's Cryogenic Noise Standard is a noise source with primary reference performance. Providing precision calibration of low noise components such as amplifiers, diode noise sources or receiver systems, it offers the ultimate in performance. The unique design covers 18 to 500 GHz in standard waveguide bands, incorporating replaceable waveguide assemblies. The standard is particularly suited to mm and sub-mm wave [THz] low noise measurement applications.

General Features

- Side entry design with convenient connections to waveguide systems
- Vertical or horizontal waveguide orientation – no mismatched bends or twists required
- Low maintenance, compact temperature stabilization system – no water cooling
- Interchangeable waveguide feed-horn assemblies provide mm to sub-mm wave [THz] coverage
- Automatic or manual LN2 filling-auto fill minimizes LN2 use and allows continuous operation
- Fully automated operation with integrated PC
- Real time noise temperature display at any frequency with full data logging

Specifications

| Cryostat Model | Frequency (GHz) | Feed-horn Assembly | Effective Noise Temperature (K) ⁻¹ | Accuracy, deg K | Waveguide |
|---------------------|-----------------|--------------------|---|----------------------|--------------------------|
| THZPN-18-110 | 50 – 75 | THZA-15-NS | 76.67 | -0.54 / +0.55 | WR 15, UG 385/U |
| THZPN-18-110 | 75 – 110 | THZA-10-NS | 76.02 | -0.59 / +0.50 | WR 10, UG 387/U-M |
| THZPN-110-500-FS | 90 – 140 | THZA-8-NS | 76.00 | -0.54 / +0.54 | WR 08, UG 387/U-M |
| THZPN-110-500-FS | 110 – 170 | THZA-6-NS | 75.01 | -0.59 / +0.60 | WR 06, UG 387/U-M |
| THZPN-110-500-FS | 140 – 220 | THZA-5-NS | 74.56 | -0.59 / +0.60 | WR 05, UG 387/U-M |
| THZPN-110-500-FS | 220 – 275 | THZA-3.4FA-NS | 74.20 | -1.16 / +1.20 | WR 3.4, UG 387/U-M |
| THZPN-110-500-FS | 275 – 325 | THZA-3.4FB-NS | 73.08 | -1.16 / +1.20 | WR 3.4, UG 387/U-M |
| THZPN-110-500-FS | 325 – 400 | THZA-2.2FA-NS | 72.27 | -1.46 / +1.55 | WR 2.2, UG 387/U-M |
| THZPN-110-500-FS | 400 – 500 | THZA-2.2FB-NS | 70.44 | -1.46 / +1.54 | WR 2.2, UG 387/U-M |

Notes

1. Average mid band noise temperature
2. Auto fill option adds a 35 litre LN2 dewar and an automatic LN2 dispenser
3. **How to make a request:** Indicate the cryostat and feed-horn assembly (s) required; Specify manual or automatic liquid nitrogen filling.
4. Email to: sales@vivatechthz.com

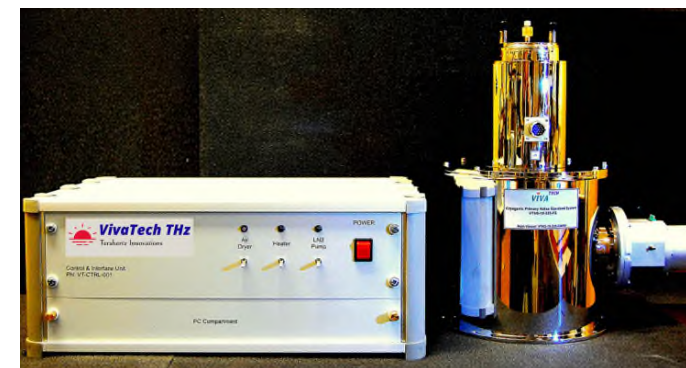

Fig 1 Noise Standard Cryostat with Controller

Fig 2 Output Temperature Display

